



Ocean FX Miniature Spectrometer User Manual



For Product: OCEAN FX
Document: 226-00000-000-01
Version: 1.5

A HALMA COMPANY

AMERICAS & WORLD HEADQUARTERS

Phone: +1 727-733-2447
Fax: +1 727-733-3962

Sales: info@oceanoptics.com
Orders: orders@oceanoptics.com
Support: techsupport@oceanoptics.com

Ocean Optics, Inc.
830 Douglas Ave.
Dunedin, FL 34698
USA

Manufacturing & Logistics
4301 Metric Dr.
Winter Park, FL 32792
USA

EUROPE, MIDDLE EAST & AFRICA

Phone: +31 26-319-0500
Fax: +31 26-319-0505
Email: info@oceanoptics.eu

Germany : +49 711-341696-0
UK : +44 1865-811118
France : +33 442-386-588

Sales & Support
Geograaf 24
6921 EW Duiven
The Netherlands

Manufacturing & Logistics
Maybachstrasse 11
73760 Ostfildern
Germany

ASIA

Phone: +86 21-6295-6600
Fax: +86 21-6295-6708
Email: asiasales@oceanoptics.com

Japan & Korea: +82 10-8514-3797

Ocean Optics Asia
666 Gubei Road
Kirin Tower Suite 601B
Changning District
Shanghai
PRC, 200336
www.oceanoptics.cn

www.oceanoptics.com

Copyright © 2017 Ocean Optics, Inc.

All rights reserved. No part of this publication may be reproduced, stored in a retrieval system, or transmitted, by any means, electronic, mechanical, photocopying, recording, or otherwise, without written permission from Ocean Optics, Inc.

Trademarks

All products and services herein are the trademarks, service marks, registered trademarks or registered service marks of their respective owners.

Limit of Liability

Every effort has been made to make this manual as complete and as accurate as possible, but no warranty or fitness is implied. The information provided is on an "as is" basis. Ocean Optics, Inc. shall have neither liability nor responsibility to any person or entity with respect to any loss or damages arising from the information contained in this manual.

Table of Contents

Compliance	vi
Warnings & Cautions	viii
About This Manual	ix
Document Summary	ix
Product-Related Support and Documentation	x
Warranty	xi
Chapter 1	1
Introduction	1
Product Introduction	1
Product Features	2
Typical Applications	3
Product Versions	5
Chapter 2	6
How the Ocean FX Spectrometer Works	6
Overview	6
Chapter 3	11
Installation and Setup	11
What's In the Box	11
Ocean FX Installation	12
Software Installation	12
About OceanView	13
Initial Configuration	13
Configuration for USB Connection	14
Configuration for Ethernet Connection	18
Configuration for WiFi Connection	25
Configuration for AP WiFi Connection	31
Power Sequences	38
Experiment Setup	39
Ocean FX Indicator Lights	40
Interchangeable Slits	40

Changing the Interchangeable Slits	40
Accessories.....	42
Cables and Connectors	42
Breakout Box (HR4-BREAKOUT).....	42
Light Sources, Cuvette Holders and Other Accessories	42
Measurement Techniques – Typical Set-ups.....	43
Common UV-Vis Applications.....	43
Reflectance & Transmission	44
Common UV-Vis Reflectance Applications.....	44
Common UV-Vis Transmission Applications	44
Fluorescence.....	45
Common Fluorescence Applications	45
Irradiance
Chapter 4	48
Ocean FX Operation with OceanView	48
Overview	48
Launch OceanView	48
OceanView Main Screen.....	49
Connect the Ocean FX in OceanView	50
Set Acquisition Parameters.....	51
Continuous and Single Acquisitions	54
Save Data	54
Saved Data Panel	54
Projects and Methods	55
Spectroscopy Application Wizards	56
Dark and Reference Measurements.....	56
Schematic View	57
Chapter 5	58
Troubleshooting	58
Overview	58
Microsoft Windows Operating Systems	60
Apple Mac OSX Operating Systems.....	60
Linux Operating Systems.....	60
Chapter 6	65

Technical Specifications	65
Mechanical Diagram	65
Absolute Maximum Ratings.....	66
Performance Specifications.....	66
Accessory Connectors	69
DD4 Accessory Connector.....	69
I2C.....	71
DB15 Connector Cable (FLAME-CBL-DD4P-DB15P).....	71
Chapter 7	73
Calibration	73
Overview	73
Wavelength Calibration	73
About Wavelength Calibration	73
Calibrating the Spectrometer Wavelength	74
Preparing for Calibration	74
Calibrating the Wavelength of the Spectrometer.....	74
Irradiance Calibrations	76

Tables

Table 1	ix
Table 2	2
Table 3	4
Table 4	5
Table 5	5
Table 6	7
Table 7	8
Table 8	12
Table 9	40
Table 10	66
Table 11	66
Table 12	67
Table 13	68
Table 14	68
Table 15	70
Table 16	72

Compliance

WARNING



This is a FCC Class A product. In a domestic environment, this product may cause radio interference in which case the user may be required to take adequate measures.



FCC COMPLIANCE

This equipment has been tested and found to comply with the limits for a Class A digital device, pursuant to Part 15 of the FCC Rules. These limits are designed to provide reasonable protection against harmful interference when the equipment is operated in a commercial environment. This equipment generates uses and can radiate radio frequency energy and, if not installed and used in accordance with the instruction manual, may cause harmful interference to radio communications. Operation of this equipment in a residential area is likely to cause harmful interference in which the user will be required to correct the interference at his own expense.

WARNING



The authority to operate this equipment is conditioned by the requirement that no modifications will be made to the equipment unless the changes or modifications are expressly approved by the manufacturer.



WEEE COMPLIANCE

The WEEE symbol on the product indicates that the product must not be disposed of with normal household waste. Instead, such marked waste equipment must be disposed of by arranging to return to a designated collection point for the recycling of waste electrical and electronic equipment. Separating and recycling this waste equipment at the time of disposal will help to conserve natural resources and ensure that the equipment is recycled in a manner that protects human health and the environment.



TUV CERTIFICATION

This device has been tested and complies with the following standards:

EN 61326-1:2013

CISPR 11:2009.A1:2010

CAN ICES-003, issue 6



EMC 2014/30/EU

RoHS-compliant

ISO COMPLIANCE

Ocean Optics, the industry leader in miniature photonics, has been certified for ISO 9001:2015 certification applicable to the design and manufacture of electro-optical equipment since 2009.

Warnings & Cautions

Warnings



This device may cause radio interference or may disrupt the operation of nearby equipment. It may be necessary to take mitigation measures such as re-orienting, relocating or shielding the location.

Cautions

- Caution:** Do not let contaminants get into the bench. Keep the protective cap on the slit aperture when not connected to an accessory, probe or fiber.
- Caution:** Only change the slit aperture in a clean environment where contaminants including dust cannot enter the bench during the procedure.
- Caution:** Substitution of a component or accessory different from that supplied may result in measurement error, equipment damage, increased emissions or decreased immunity.
- Caution:** Repairs should be undertaken only by personnel trained or authorized by Ocean Optics. The device does not contain any user serviceable parts.
- Caution:** Do not immerse the device in any fluid, place fluids on top of or attempt to clean with liquid detergents or cleaning agents. This may cause an electrical hazard. Do not use if accidental wetting occurs.
- Caution:** Do not remove any covers. Doing so may increase the risk of electrical shock or compromise the integrity of the optical components.
- Caution:** Do not gas sterilize or autoclave this device.
- Caution:** Consult local codes and ordinances for proper disposal of equipment and other consumable goods.
- Caution:** The device and/or accessories may not operate correctly if used or stored outside the relevant temperature and humidity ranges described in the Technical Specifications.
- Caution:** Do not use if device is dropped and/or damaged. Have an authorized service representative check the device before using again.
- Caution:** Be sure to install any software BEFORE connecting the spectrometer to your PC. The software installs the drivers required for spectrometer installation. If you do not install the software first, the system will not properly recognize the spectrometer.
- Caution:** To ensure reliable operation, it is recommended that the power supply be attached prior to inserting the USB connector.
- Caution:** The user of this spectrometer shall have the sole responsibility for any malfunction which results from improper use, faulty maintenance, improper repair, damage or alteration by anyone other than Ocean Optics or their authorized service personnel.

About This Manual

Document Summary

Chapter	Description
Chapter 1: Introduction	Introduces the product features. Contains descriptive information about the Ocean FX Spectrometer. It also provides a list of system requirements, typical applications, and product versions.
Chapter 2: How the Ocean FX Spectrometer Works	Describes how the Ocean FX operates, illustrating the various parts and functions.
Chapter 3: Installation and Setup	Provides installation instructions, including how to set up the Ocean FX with OceanView. Also includes package contents and typical set-ups for different measurement techniques.
Chapter 4: Ocean FX Operation with OceanView	Describes how to use the Ocean FX with OceanView software, including how to connect, acquire, save and other basic features.
Chapter 5: Troubleshooting	Contains recommended steps to isolate and correct common problems.
Chapter 6: Technical Specifications	Contains technical specifications and connector pinouts for the Ocean FX Spectrometer.
Chapter 7: Calibration	Provides information for calibrating the Ocean FX Spectrometer.

Table 1

ACRONYMS & SYMBOLS

MISO	Master Input, Slave Output
IEEE	Institute of Electronic and Electrical Engineers
MOSI	Master Output, Slave Input
Rx	Receive
SPI	Serial Peripheral Interface
Tx	Transmit
USB	Universal Serial Bus
Vusb	Voltage, USB
WiFi	Wireless Fidelity
FWHM	Full Width Half Maximum – optical resolution units
CMOS	Complementary metal oxide semiconductor – type of detector
CCD	Charged Coupled Device - type of detector
TEC	Thermoelectric Cooling

Product-Related Support and Documentation

You can access product documentation for Ocean Optics products by visiting our website at <http://www.oceanoptics.com>. Go to the Ocean FX product page for general product details, specifications and application notes. Additional technical documents and programs can be accessed through the Support tab which includes software downloads, getting started guidance, frequently asked questions and technical documents for topics including OceanView Software, light sources, electronic accessories, sampling accessories, fibers & probes, external triggering, changing the slit size and device driver guidance.

Ocean Optics offers a Glossary of spectroscopy terms to help you further understand your state-of-the-art products and how they function located in the Knowledge section which also offers example setups, application blogs, videos through SpectroscopyTV.com and other ways of learning about spectroscopy.

Warranty

Our 3-Year Warranty covers Ocean Optics miniature fiber-optic spectrometers, spectral sensors, light sources and sampling accessories – regardless of the application – from defects in materials and workmanship from the date of purchase. It also covers fibers and probes for a full 12 months.

The warranty covers parts and labor needed to repair manufacturing defects that occur during the warranty period. We also will cover the costs of shipping warranty-related repairs from our customers to Ocean Optics and from us to our customers. Repairs and upgrades are covered for manufacturing defects for 6 months from the date of purchase from Ocean Optics.

Normal wear, scratching and cosmetic damage not affecting the performance, bulbs, batteries, consumables and vendor items are not covered by this Ocean Optics limited warranty. For vendor items, the manufacturer's warranty terms are in force and vary from product to product. These causes are not covered by this warranty: damage caused by accident, misuse – such as using an incorrect power supply or power current – abuse, product modification or neglect; damage occurring during shipment; damage resulting from the performance of repairs by someone not authorized by Ocean Optics; damage caused by installation of parts that do not conform to Ocean Optics specifications; units not used for their intended purpose; and any claims made based on misrepresentations of the seller and costs associated with installation of the unit.

Ocean Optics' liability is limited to the repair or the replacement, at our option, of any defective item and shall not include incidental or consequential damages whatsoever. Ocean Optics reserves the right to replace a discontinued model with a functionally comparable model. If you require warranty service, please contact the Customer Service Department of Ocean Optics at +1.727.733.2447 or fill out a Return Merchandise Authorization (RMA) form located in the Support section of our website.

Chapter 1

Introduction

Product Introduction

The Ocean FX is a miniature modular spectrometer with enhanced connectivity and onboard processing that is based upon Ocean Optics' Cross Czerny-Turner design. Ocean FX is built using manufacturing techniques that help deliver high thermal stability and low unit to unit variation without compromising the flexibility and configurability that are the hallmark of the design. Features such as interchangeable slits, indicator Lights and simpler device connectors deliver more freedom and less frustration. In addition, Ocean FX utilizes a host of communication options including USB 2.0, Gigabit Ethernet, RS232, 802.11a/b/g/n WiFi and Access Point WiFi.



Ocean FX Spectrometer

Product Features

Fast Acquisition Speed	Integration times down to 10 μ s where spectra can be captured up to 4500 spectra/second
Sensitive	Responsive from 200 – 1100 nm with great sensitivity in the UV and NIR
Multiple Configurations	Incredibly configurable, with millions of configurations across the wavelength range 200-1100nm
Large Onboard Memory	Onboard buffering stores up to 50,000 timestamped spectra so you will not miss a single data point
Onboard Averaging	Increase signal-to-noise by averaging onboard and reduce transfer times
Expanded Connectivity	Gigabit Ethernet, WiFi, Access Point WiFi, USB and RS-232 for easy integration into almost any system as well as 8 GPIO for connection to external devices
On-the-fly Slit Modifications	User-interchangeable slit allows quick changes to resolution and throughput allowing one spectrometer to perform multiple types of experiments such as absorbance and fluorescence.
High Thermal Stability	Allows for accurate and repeatable measurements in demanding environments
Portable Robust Design	Compact, rugged and lightweight for use in the lab or in remote applications

Table 2

Typical Applications

Application Area	Examples
Light Laser LED	Laser Characterization
	LED Measurement
	Light Metrology Measurement
Research and Education	Applied Research
	Basic Research
	Teaching Labs for Physics, Chemistry, Biomed
Life Sciences	Biotechnology
	Medical Diagnostics
	Protein and Nucleic Acid Analysis
Materials Identification	Biomaterial Analysis
	Metallurgical Analysis
	Polymer Analysis
	Semiconductor Materials Analysis
Semiconductors Processing and Thin Film Metrology	Plasma Monitoring
	Process Endpoint Detection
	Thickness Measurement
Farm to Table Technologies	Agricultural Measurements and Monitoring
	Food and Beverage Quality Control
	Food Safety

Application Area	Examples
Energy Technologies	Biofuels Analysis
	Mining and Exploration
	Oil and Petroleum Analysis
	Photovoltaic Analysis
	Solar Simulators
Anti-Counterfeit	Testing and Qualification
	Product Identification and Authentication
Quality Control and Process Monitoring	Defect Identification
	Raw Material Inspection
	Verification Testing
Environmental Monitoring	Air and Water Quality Analysis
	Remote Sensing
	Volcanic Research

Table 3

You can find more information about applications of UV-Vis spectroscopy and the Ocean FX at www.oceanoptics.com.

Specifications Summary

Spectral range	200 - 1100 nm (configurable within this range)
Optical resolution	2.39 pixels (FWHM)
SNR (single scan)	290:1
Dynamic range (single scan)	5000:1
Integration time	10 μ s – 10 seconds
Scan rate (maximum)	4500 scans/second
Thermal stability	0.11 pixels/ C
Entrance slit	5, 10, 25, 50, 100 or 200 μ m width slits
Input fiber connector	SMA 905 or FC

Table 4

Product Versions

Many variants of the Ocean FX Spectrometer exist. Ocean Optics offers both preconfigured units as well as custom-configured units, enabling you to order a customized spectrometer optimized for your application. You can determine spectrometer details by looking at the product code located on the bottom of your spectrometer.

Error! Reference source not found.

OCEAN FX Preconfigured Models						
	Model	Range (nm)	Slit (μ m)	Optical Resolution (nm)	Grating #	Lens
General Purpose	OCEAN FX-UV-VIS	200-850	25	1.5	1	none
	OCEAN FX-UV-VIS-ES					L2
	OCEAN FX-VIS-NIR	350-1000	25	1.5	3	none
	OCEAN FX-VIS-NIR-ES					L2
Extended Range	OCEAN FX-XR1	200-1025	25	2	31	none
	OCEAN FX-XR1-ES					L2

Table 5

For more information and specifications on preconfigured models, see www.oceanoptics.com.

How the Ocean FX Spectrometer Works

Overview

This section provides an overview of the Ocean FX spectrometer and how it works from light entering the slit to the communication of the spectrum to a connected device. It also provides an overview of all the different possible configurations that are possible, designed to help you optimize your spectrometer for specific applications.

You'll find more useful information, including a [glossary of spectroscopy and spectrometer terms](#), on our website at www.oceanoptics.com.

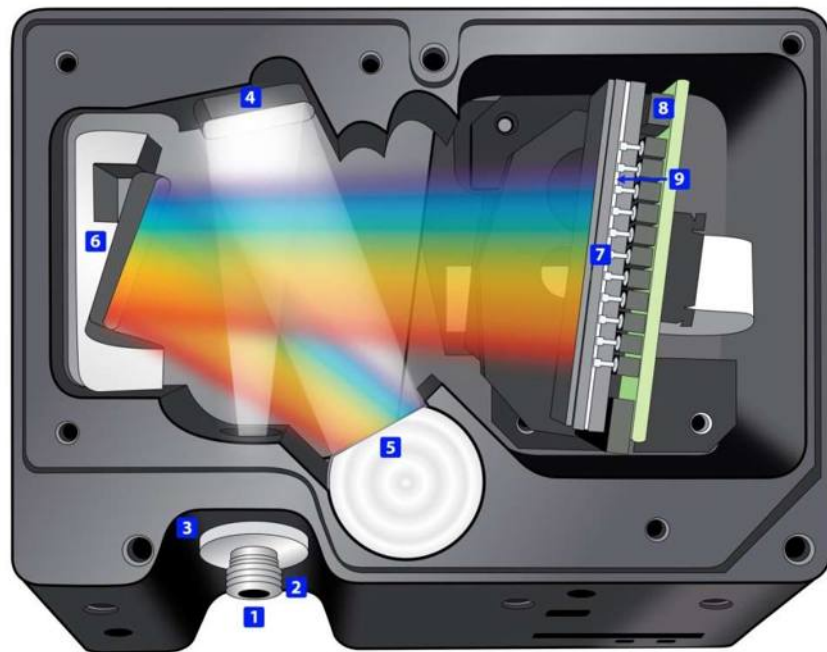

Ocean FX Open Bench

1. **Fiber Optic Connector:** Light from a fiber enters the optical bench through the SMA 905 Connector. The SMA 905 bulkhead provides a precise location for the end of the

optical fiber, slit, absorbing filter and fiber clad mode aperture. While we supply SMA connectors as standard, FC connectors are also available. See #2 for available options.

2. **Interchangeable Slit:** Light passes through the installed slit, which acts as the entrance aperture. Slits come in various widths from 5 μm to 200 μm and the slit is fixed in the SMA 905 bulkhead to sit against the end of a fiber. Smaller slit sizes achieve the best optical resolution while larger slits have higher light throughput. Slit size is labeled on the aperture as shown in the photo.



Slit	Description	Pixel Resolution
INTSMA-5	5- μm wide x 1-mm high	3.0 pixels
INTSMA-10	10- μm wide x 1-mm high	3.2 pixels
INTSMA-25	25- μm wide x 1-mm high	4.2 pixels
INTSMA-50	50- μm wide x 1-mm high	6.5 pixels
INTSMA-100	100- μm wide x 1-mm high	12 pixels
INTSMA-200	200- μm wide x 1-mm high	24 pixels
INTSMA-000	Interchangeable bulkhead with no slit	NA
INTSMA-KIT	Interchangeable SMA Kit connectors; 5 μm ; 10 μm ; 25 μm ; 50 μm ; 100 μm and 200 μm	NA

Table 6

Ocean Optics also offers a range of FC connector slits in the same wavelengths, with the product code INTFC-XXX. An INTFC-KIT is also available. Note that these items are made to order and have a longer lead time. Contact an Ocean Optics Application Sales Engineer for more details.

► **Procedure**

To calculate the optical resolution for your spectrometer:

- Find the number of pixels for your detector.
- Divide the range of the spectrometer by the number of detector pixels.
- Multiply this number by the pixel resolution from the table above.

Example: Optical Resolution with 50 μm slit, 650 nm Spectral range: $650/2048 \times 6.5 = 2.1 \text{ nm}$

3. **Absorbing Filter (optional):** If selected, an absorbing filter is installed between the slit and the aperture in the SMA 905 bulkhead. The filter is used to limit bandwidth of light entering spectrometer or to balance color. Filters are installed permanently. A filter is for a specific slit. If you anticipate needing the filter with multiple slit sizes, then you must specify this at the time you order. You will know which filter is installed in each slit because of the color-coded dots on the outside as shown in the figure and described in the table below.



Item Code	Description	Dot 1	Dot 2
OF1-BG28	Bandpass filter, transmits >325 and <500 nm	blue	red
OF1-WG305	Longpass filter; transmits light >305 nm	black	white
OF1-U325C	Bandpass filter, transmits >245 and <390 nm	white	green
OF1-GG375	Longpass filter; transmits light >375 nm	red	black
OF1-GG395	Longpass filter; transmits light >395 nm	white	red
OF1-CGA420	Longpass filter; transmits light >420 nm	orange	white
OF1-GG475	Longpass filter; transmits light >475 nm	green	green
OF1-OG515	Longpass filter; transmits light >515 nm	pink	yellow
OF1-OG550	Longpass filter; transmits light >550 nm	orange	orange
OF1-OG590	Longpass filter; transmits light >590 nm	red	pink
OF1-RG695	Longpass filter; transmits light >695 nm	white	blue
OF1-RG830	Longpass filter; transmits light >830 nm	black	blue
OF1-CGA1000	Nonfluorescing longpass filter, transmits >1000 nm	red	green
OF1-CGA760	Nonfluorescing longpass filter, transmits >760 nm	blue	black
OF1-CGA780	Nonfluorescing longpass filter, transmits >780 nm	white	yellow
OF1-CGA830	Nonfluorescing longpass filter, transmits >830 nm	green	orange
OF1-CGA475	Nonfluorescing longpass filter, transmits >475 nm	yellow	pink

Table 7

4. **Collimating Mirror (specify Standard or SAG+):** Light reflects from the collimating mirror as a collimated beam toward the grating. You can opt to install a standard mirror or a NIR-enhancing but UV absorbing SAG+ mirror.

SAG+ mirrors are often specified for fluorescence. These mirrors absorb nearly all UV light, which reduces the effects of excitation scattering in fluorescence measurements. Unlike typical silver-coated mirrors, the SAG+ mirrors won't oxidize. They have excellent reflectivity — more than 95% across the VIS-NIR.

Specify standard or SAG+ mirrors when ordering your spectrometer.

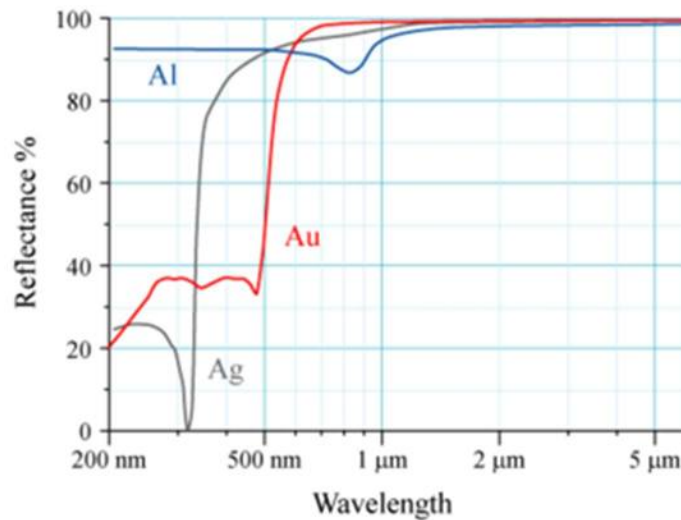

Reflectance vs. Wavelength for Aluminum, Gold, and Silver Mirrors

By Bob Mellish in Wikipedia

- Grating:** In optics, a diffraction grating is an optical component with a periodic structure that splits and diffracts light into several beams traveling in different directions. The directions of these beams depend on the spacing of the grating and (most importantly for spectroscopy) the wavelength of the light. In a spectrometer, the grating acts as the dispersive element. Most spectrometers make use of a grating to split the incoming beam of light into its component wavelengths. This makes use of the optical principle of diffraction; that different wavelengths will be transmitted or reflected from a dispersive element through varying angles, thereby separating one multi-wavelength beam into many single-wavelength beams. Typically, a balance must be struck between these two parameters: as you increase the number of lines/mm on a grating, you increase resolution but decrease the wavelength range that may be scattered.

Use our online [Range and Resolution Calculator](#) to find out how your grating choice affects spectral range and optical resolution by viewing the grating efficiency curves.

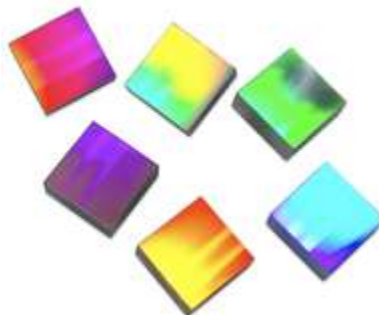

Gratings Showing Light Diffracted into its Constituent Wavelengths

- 6. Focusing Mirror (specify standard or SAG+):** This mirror focuses first-order spectra on the detector plane. Both the collimating and focusing mirrors are made in-house to guarantee the highest reflectance and the lowest stray light possible. You can opt to install a standard or SAG+ mirror. As with the collimating mirror, the mirror type needs to be specified when ordering.
- 7. Detector Collection Lens (optional):** This cylindrical lens is fixed to the detector to focus the light onto the detector elements. It increases light-collection efficiency and reduces stray light. It also is useful in a configuration with a large-diameter fiber and slit for low light-level applications such as fluorescence. Preconfigured Ocean FX spectrometers with a collector lens are available – look for –ES at the end of the name.



- 8. Detector:** Ocean FX utilizes a Hamamatsu S11639-01 linear silicon CMOS array detector. Similar to CCD detectors, a CMOS detector also converts incident photons into an electric charge. But each CMOS detector pixel has an amplifier attached that transfers the accumulated charge after a measurement has been made to the A/D converter. CMOS detectors can typically operate at much higher speeds than CCD detectors.
- 9. Detector Window:** The detector includes a clear, quartz window that often includes an order-sorting filter designed to block second and third order diffraction effects. Light reflected off the grating can propagate these 2nd and 3rd order effects at whole multiples of the incident light. Order-sorting filters reject this stray light only allowing the desired wavelength through to the detector.

Installation and Setup

What's In the Box

- ❑ **Ocean FX Spectrometer**
Your Ocean FX spectrometer arrives pre-calibrated and ready to plug and play.
- ❑ **Universal Power Supply**
Your Ocean FX spectrometer comes with an external power supply and includes multi-country plugs.
- ❑ **USB Cable**
Cable to connect your spectrometer to a USB port on a computer running on a Windows, Mac or Linux operating system.
- ❑ **Ethernet Cable**
Cable to connect your spectrometer to your network switch. The supplied cable supports Gigabit speed.
- ❑ **Getting Started Reference Card**
The Ocean Optics Getting Started reference will guide you in ways that you can find further information to configure and use your spectrometer and software.
- ❑ **Wavelength Calibration Data Sheet**
Each spectrometer is shipped with a Wavelength Calibration Data Sheet that contains information unique to your spectrometer. OceanView reads this calibration data from your spectrometer when it interfaces to a computer.
- ❑ **Warranty Information**
Ocean Optics spectrometer warranty is 3 years and this is printed on the packaging box.

Ocean FX Installation

The following procedure provides general instructions for getting your new Ocean FX spectrometer up and running.

Software Installation

Caution

Be sure to install the software BEFORE connecting the spectrometer to your PC. The software installs the drivers required for spectrometer installation. If you do not install the software first, the system will not properly recognize the spectrometer.

If you have already connected the Ocean FX to a computer running on a Windows platform prior to installing the operating software, consult the Troubleshooting section for information on correcting a corrupt Ocean FX installation.

Caution

Be sure that you download the correct software package for your computer version (32 or 64-bit). See the Frequently Asked Questions in Troubleshooting section for more information on determining your computer version.

Use OceanView version 1.6.3 and above for Ocean FX. You can use OceanView on the following operating systems.

Software OS	Windows				Apple	Linux
	7	8	8.1	10		
OceanView	√	√	√	√	OS X Version 10.5 or later on Intel processor	Any version released for an x86 or amd64 platform since 2010

Table 8

About OceanView

OceanView is a user-customizable, advanced acquisition and display program that provides a real-time interface to a variety of signal-processing functions. With OceanView, you have the ability to perform spectroscopic measurements (such as absorbance, reflectance, and emission), control all system parameters, collect and display data in real time, and perform reference monitoring and time acquisition experiments. Consult the OceanView manual for hardware requirements when using OceanView.

Initial Configuration

There are 4 options for accessing the Ocean FX Spectrometer from your computer:

- USB port for a local connection (located on the back of the unit)
- Ethernet connection to your network (located on the back of the unit)
- WiFi connection to your wireless network
- Access Point (AP) WiFi direct wireless connection to a PC or Windows-based tablet (no router or switch needed)

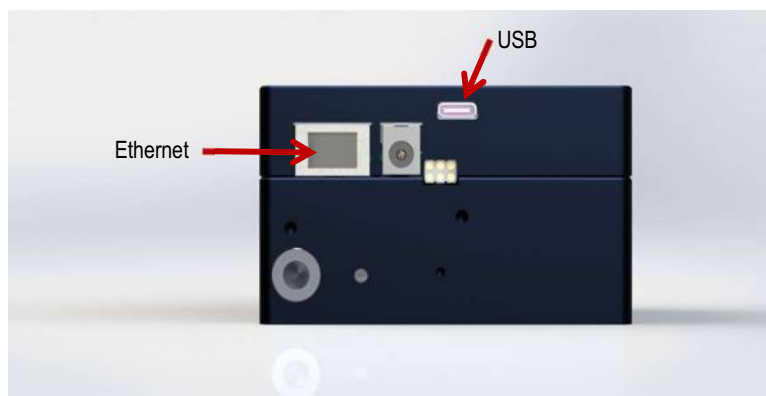

Rear View of Ocean FX Spectrometer

Important Note

BEFORE INITIALIZING ETHERNET OR WIFI, PERFORM USB INITIALIZATION FIRST.

Important Note

If multiple Ocean FX devices are being used, connection to a particular device may require disconnection and connection activities within the Device Manager of OceanView.

Configuration for USB Connection

Important Note

To ensure reliable operation, it is recommended that the Ocean FX power supply be connected prior to inserting the USB connector.

Important Note

To ensure the USB drivers are automatically loaded, the PC should be connected to the internet.

1. Install OceanView software on the destination device prior to connecting the spectrometer.
2. Connect the Ocean FX power supply to the Ocean FX and wait for the green indicator light to illuminate.
3. Connect the supplied USB cable to the USB connector on the Ocean FX and the destination device. Wait for device drivers to install before progressing.
4. Start the OceanView application.
5. If applicable, Click “No” for creating a simulation.

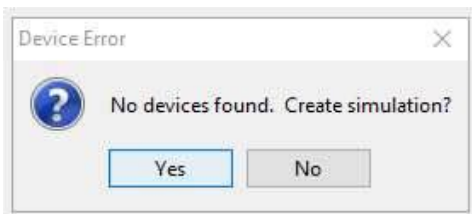

6. The Welcome Screen will be displayed. Click the “OK” button.



7. If the USB connection does not automatically connect, click on the device manager icon.

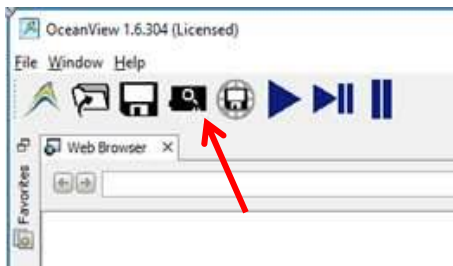

8. Verify that:
 - a. “Automatically connect to device” and “Automatically connect to remote device” **are checked**.
 - b. “Simulate device if none found” **is not checked** as shown below.

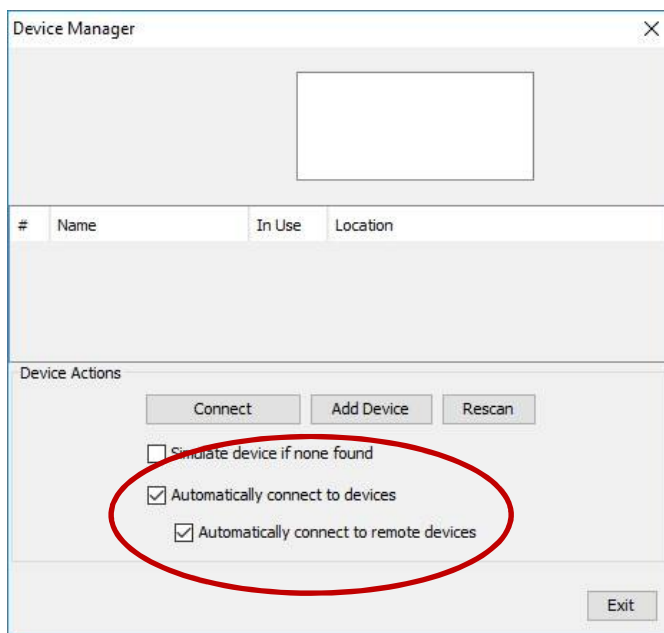

Click the Exit button.

9. Select the OceanView’s “Schematic” view if not already the active view. This can be done by clicking Schematic Window on the side bar or by choosing Schematic from the Window tab.

3: Installation and Setup

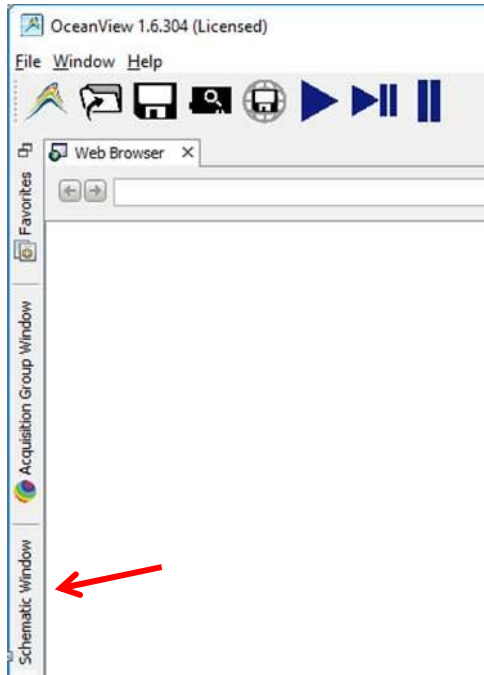

10. The Ocean FX icon will show up in OceanView's schematic window as shown below.

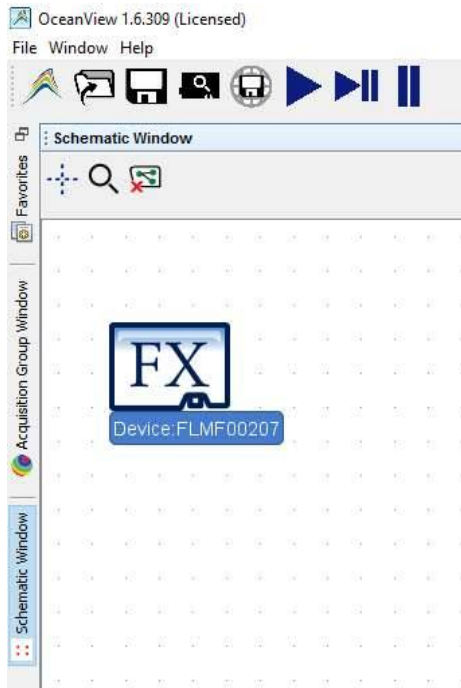

11. If the device does not appear, go back to Device Manager and click the “Rescan” button.

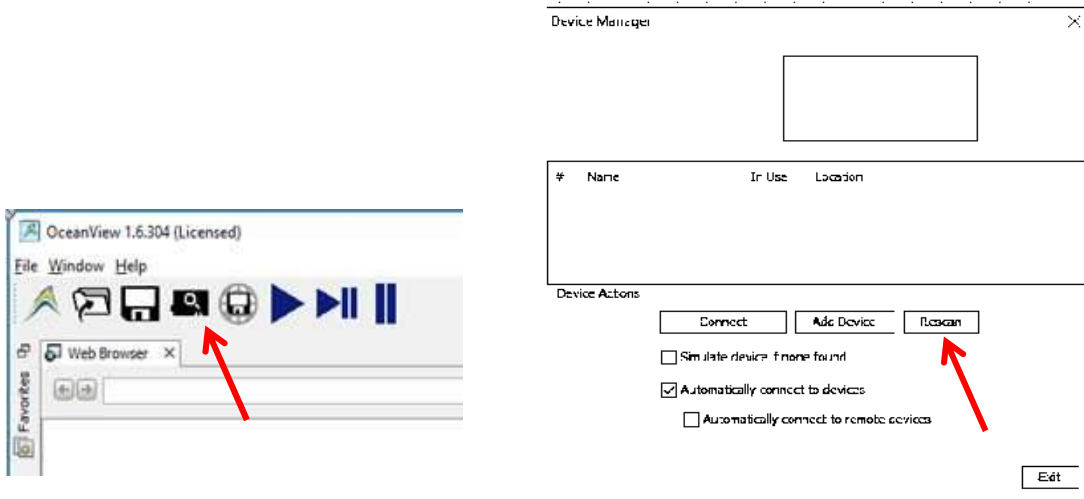

12. Your Ocean FX device will appear in the Device Manager window and in the schematic view.

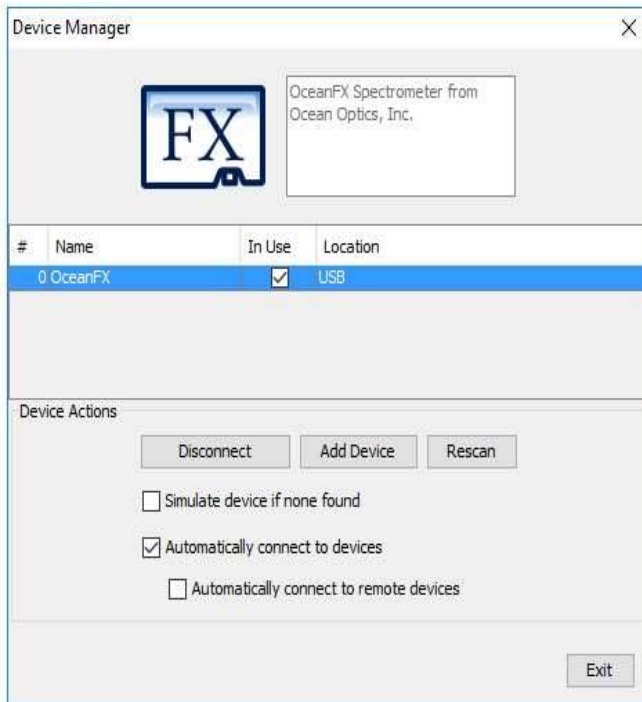

Continue your setup as described in [Experiment Setup](#) section.

Configuration for Ethernet Connection

Important Note

To ensure reliable operation, it is recommended that the power supply be connected prior to inserting the Ethernet connector.

Important Note

For Ethernet to connect properly, the host computer must be wirelessly connected to the same router as the Ocean FX Ethernet cable or the Wireless functionality within the host computer must be turned OFF.

1. Connect the Ocean FX power supply to the Ocean FX and wait for the green indicator light to illuminate. Wait an additional 90 seconds before moving on to the next step.
2. Connect USB cable provided with the Ocean FX.
3. Start the OceanView application.
4. If the Device Error screen appears, go back and perform the USB initialization procedure.



5. The Welcome Screen will be displayed. Click the "OK" button.



6. Click on the device manager icon.

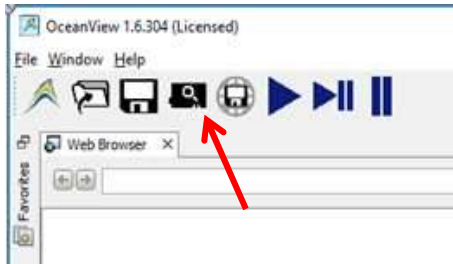

7. Verify that:
 - c. “Automatically connect to device” and “Automatically connect to remote device” **are checked**.
 - d. “Simulate device if none found” **is not checked** as shown below.

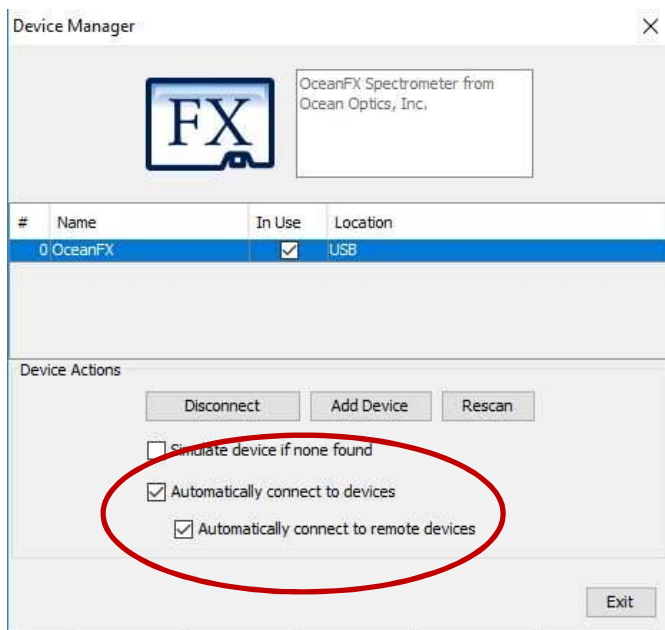

Click the Exit button.

8. Connect the supplied Ethernet cable to the Ethernet connector on the Ocean FX and to a network router.

3: Installation and Setup

9. Select the OceanView's "Schematic" view if not already the active view. This can be done by clicking Schematic Window on the side bar or by choosing Schematic from the Window tab.

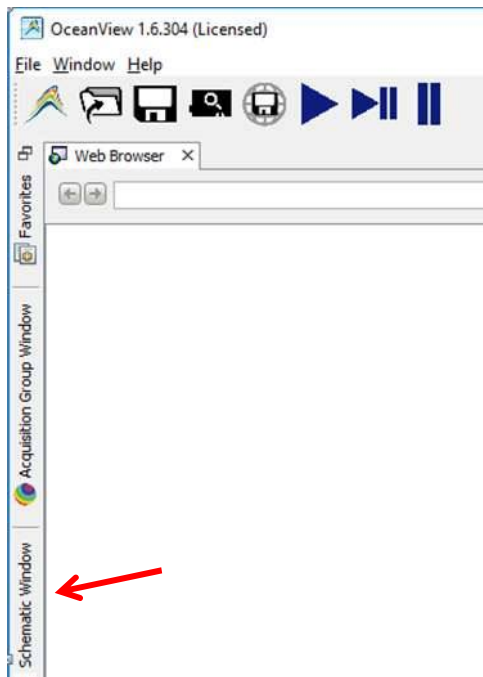

10. The Ocean FX icon will show up in OceanView's schematic window as shown below.

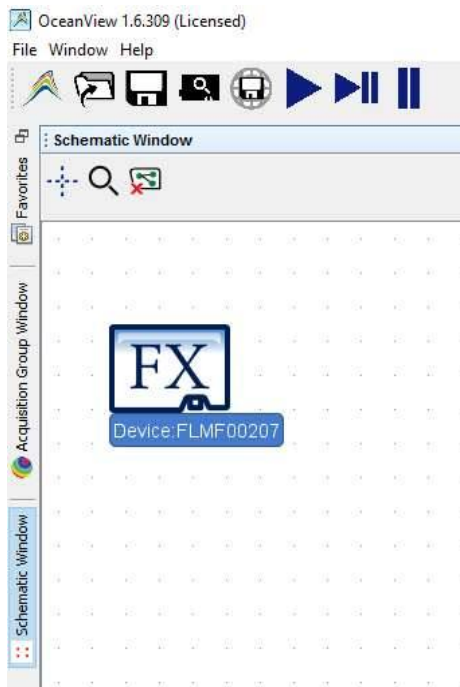

- In OceanView's schematic mode, right click on the Ocean FX icon and select "Network Setup" which opens the Network Setup window.

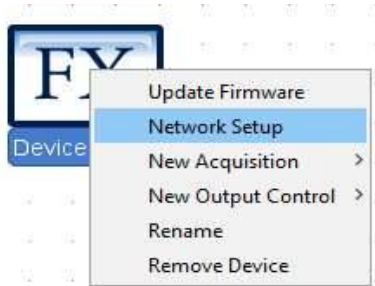

- Select Interface 0. If necessary, click the "Interface Enable" button. If the Ethernet settings do not appear under Interface 0, then close the window and right click again on the Ocean FX icon and select "Network Setup". Ethernet options will appear under Interface 0.

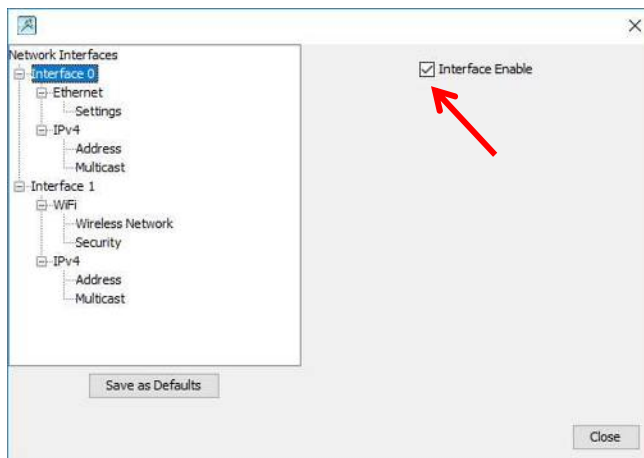

- Select "Settings" under Ethernet and click "Enable Gigabit Ethernet".

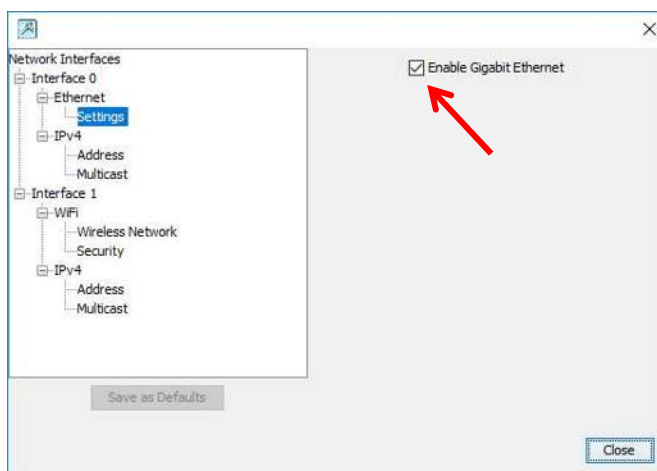

3: Installation and Setup

14. Select “Address” under IPv4 and click “Enable DHCP” and then click the Refresh button.

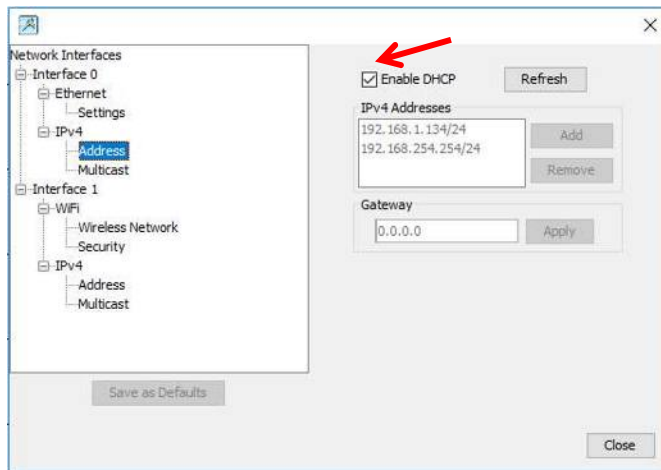

15. Select “Multicast” under IPv4 and click “Enable multicast”.

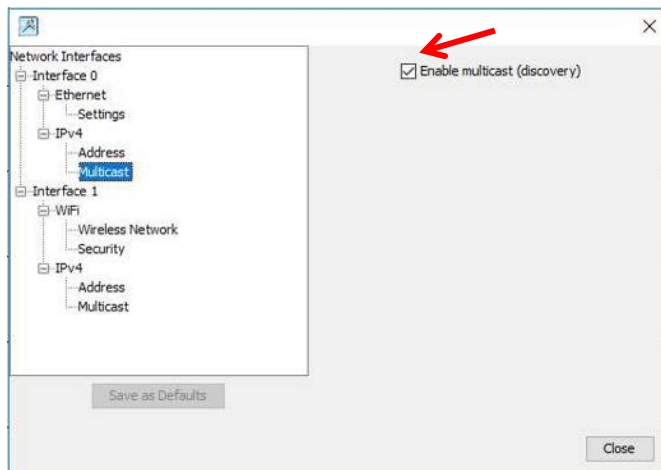

16. Select Interface0. Then click “Save as Defaults” which will upload these settings to the Ocean FX. Click the Close button.

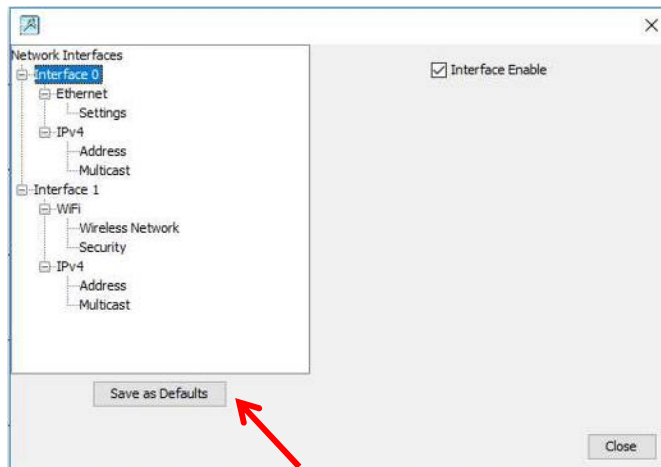

17. Close OceanView and cycle power on the Ocean FX to enable the new settings. Wait 2 minutes then restart OceanView.

18. Click on the device manager icon.

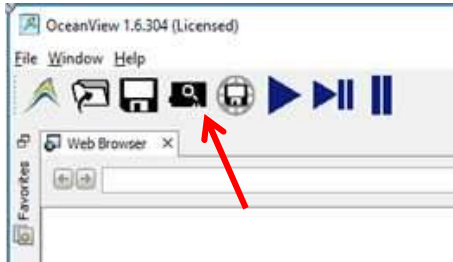

19. In Device Manager, verify that network device has been located. If necessary, click the “Rescan” button to discover the device.

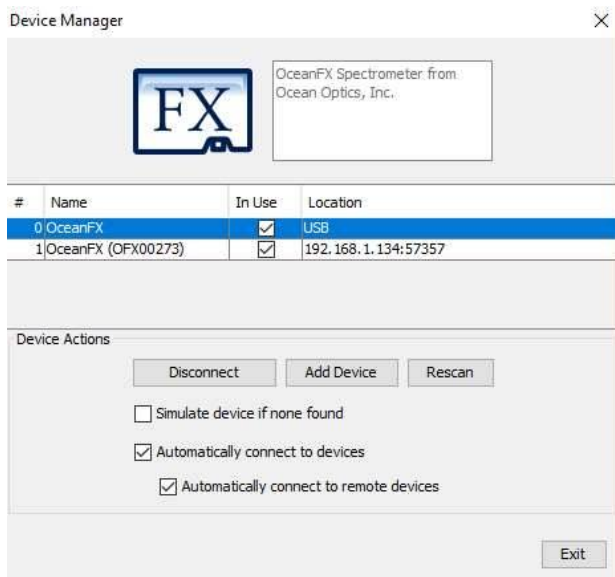

20. Verify the USB device is highlighted. Click on the “Disconnect” button for the USB device and exit Device Manager.

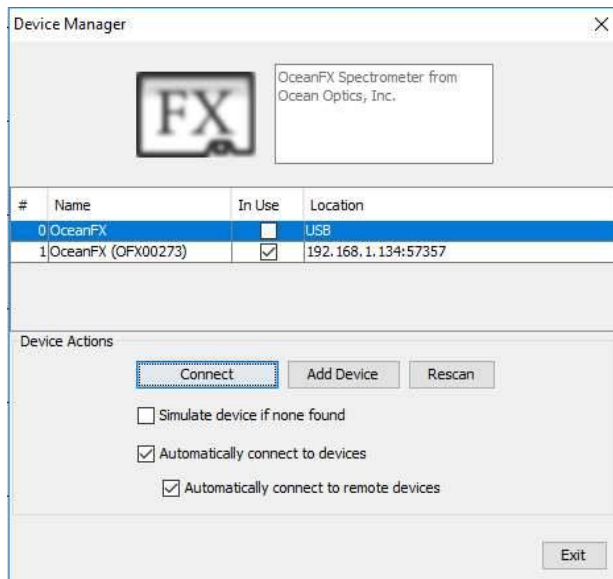

21. Disconnect the USB cable and close and restart OceanView. When restarted, the Ethernet connection will be activated.

Continue your setup as described in [Experiment Setup](#) section.

Important Note

For future Ethernet use after configuration, wait 2 minutes after powering up the Ocean FX before opening OceanView.

Configuration for WiFi Connection

Important Note

Initial configuration must be done via USB prior to attempting a WiFi connection.

Important Note

The host device with OceanView must be connected to the same WiFi router as the Ocean FX.

Important Note

Before attempting WiFi configuration, the Ocean FX must be powered on for at least 2 minutes.

Important Note

The Ocean FX should be within 15 feet of the wireless router.

1. Connect the Ocean FX power supply to the Ocean FX and wait for the green indicator light to illuminate. Wait an additional 90 seconds before moving on to the next step.
2. Connect USB cable provided with the Ocean FX.
3. Start the OceanView application.
4. If the Device Error screen appears, go back and perform the USB initialization procedure.

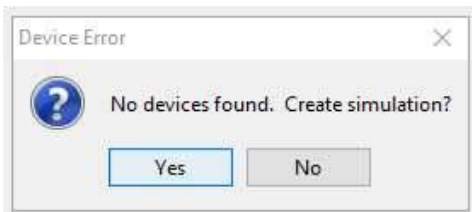

3: Installation and Setup

5. The Welcome Screen will be displayed. Click the "OK" button.



6. Click on the device manager icon.

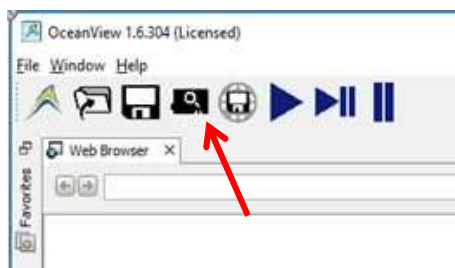

7. Verify that:

- e. "Automatically connect to device" and "Automatically connect to remote device" **are checked**.
- f. "Simulate device if none found" **is not checked** as shown below.

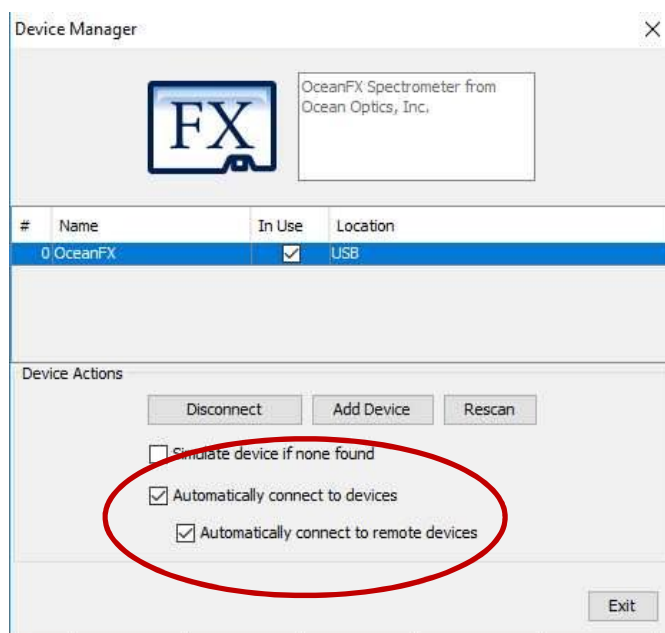

Click the Exit button.

13. In OceanView's schematic mode, right click on the Ocean FX icon and select "Network Setup" which opens the Network Setup window.

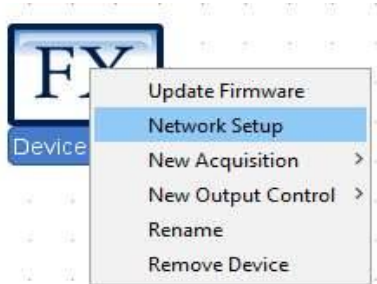

14. Select Interface 1. If necessary, click the "Interface Enable" button. If the WiFi settings do not appear under Interface 1, then close the window and right click again on the Ocean FX icon and select "Network Setup". WiFi options will appear under Interface 1.

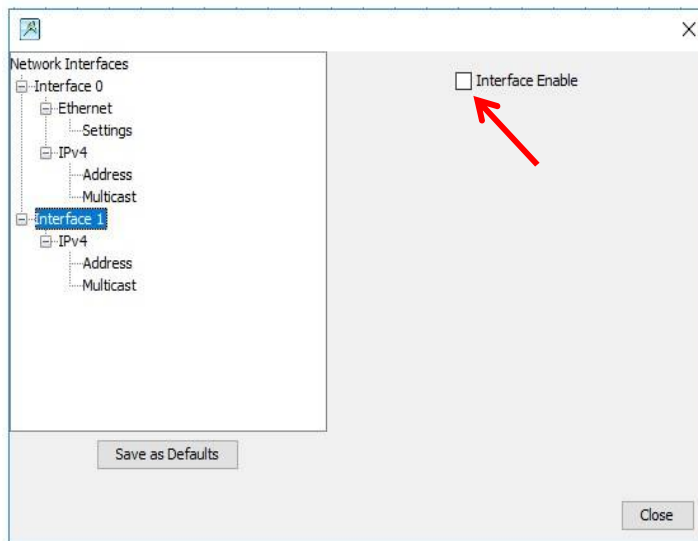

15. Select Security which will show options in the upper right corner of the screen. Select the desired security either Open or WPA2. If WPA2 is selected, enter the password or phrase that corresponds to your wireless router. Click the “Apply” button.

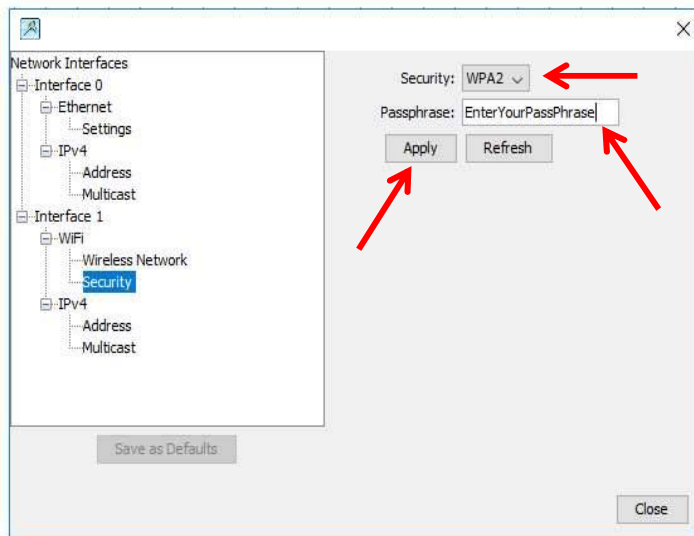

16. Then select Wireless Network under Interface 1. Mode will default to Client. Enter the SSID for the network device and click the “Apply” button.

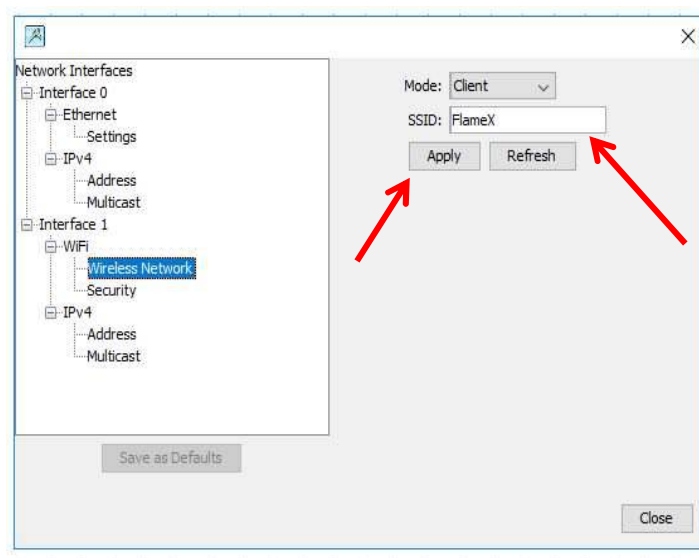

17. Select Address. Verify the “Enable DHCP” box is checked. If not, check the box and click Refresh.

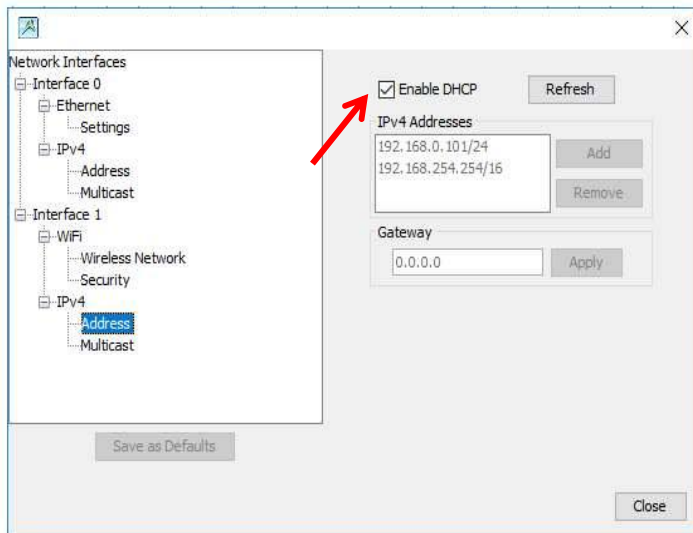

18. Select Multicast. If necessary, click the “Enable multicast (discovery)” button.

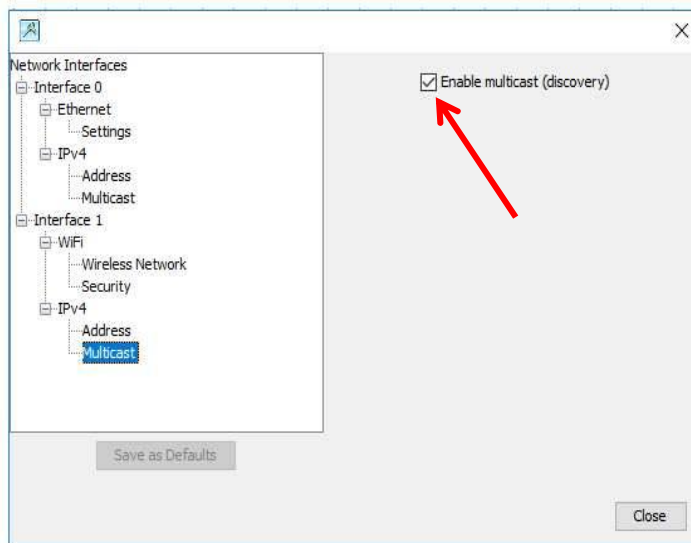

19. Select Interface 1 and then click the "Save as Defaults" button which will upload these settings to the Ocean FX. Click the Close button.

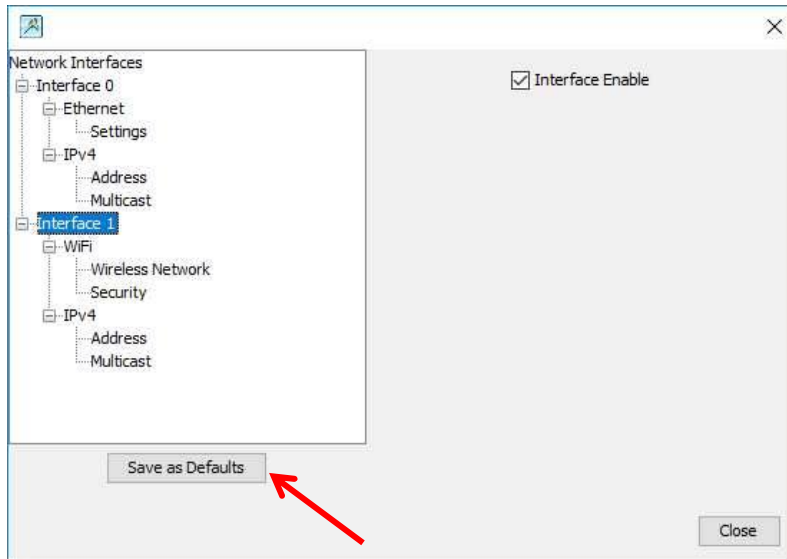

20. Disconnect USB cable from the Ocean FX.
21. Close OceanView and cycle power on the Ocean FX to enable the new settings. Wait 2 minutes then restart OceanView.
22. If device does not appear correctly, consult the troubleshooting section.

Important Note

When using WiFi after initial configuration, wait 2 minutes after powering up the Ocean FX before opening OceanView.

23. Continue your setup as described in the [Experiment Setup](#) section.

Configuration for AP WiFi Connection

Access Point (AP) WiFi is similar to Bluetooth in that it is a point-to-point or device-to-device connection and does not need a router or switch.

Important Note

Initial configuration of the Ocean FX must be done via USB prior to attempting AP WiFi connection.

Important Note

No router or switch is needed but the host device will need to wirelessly connect directly to the Ocean FX.

Important Note

Before attempting AP WiFi configuration, the Ocean FX must be powered on for at least 2 minutes.

1. Connect the Ocean FX power supply to the Ocean FX and wait for the green indicator light to illuminate. Wait an additional 90 seconds before moving on to the next step.
2. Connect USB cable provided with the Ocean FX.
3. Start the OceanView application.
4. If the Device Error screen appears, go back and perform the USB initialization procedure.

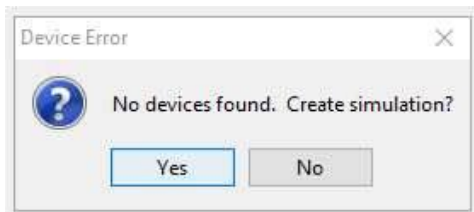

3: Installation and Setup

5. The Welcome Screen will be displayed. Click the "OK" button.



6. Click on the device manager icon.

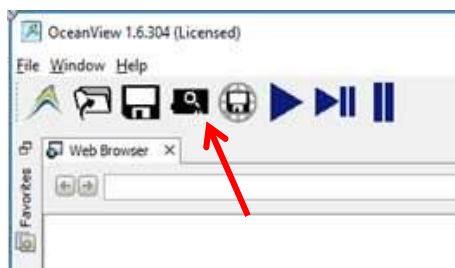

7. Verify that:

- g. "Automatically connect to device" and "Automatically connect to remote device" **are checked**.
- h. "Simulate device if none found" **is not checked** as shown below.

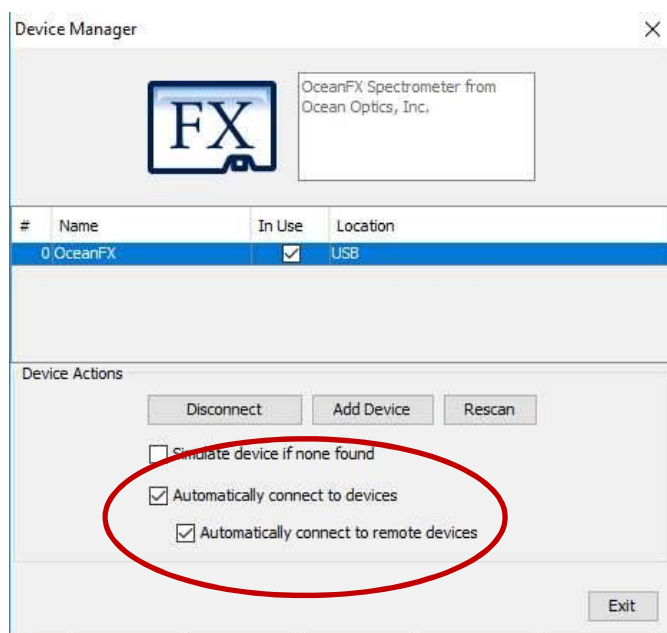

Click the Exit button.

8. In OceanView's schematic mode, right click on the Ocean FX icon and select "Network Setup" which opens the Network Setup window.

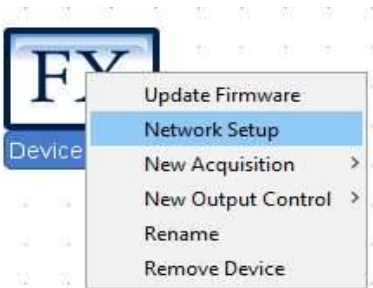

9. Select Interface 1. If necessary, click the "Interface Enable" button. If the WiFi settings do not appear under Interface 1, then close the window and right click again on the Ocean FX icon and select "Network Setup". WiFi options will appear under Interface 1.

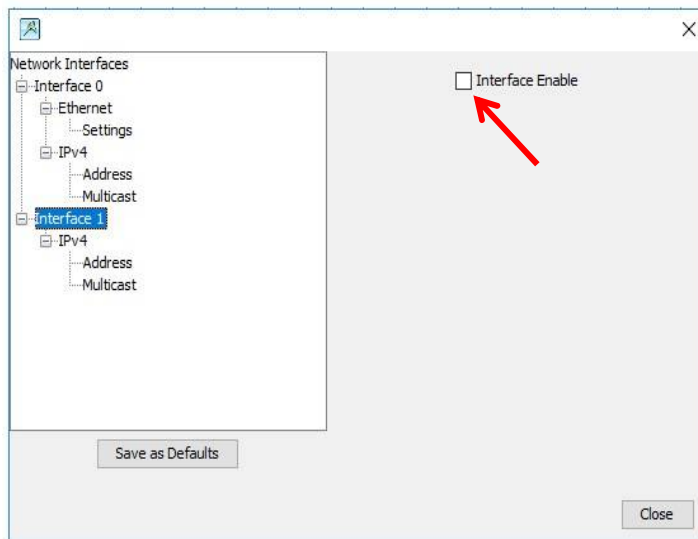

10. Select Security which will show options in the upper right corner of the screen. Select the Open option when using AP WiFi as this is a device-to-device connection. WPA2 security settings can also be used if desired. Click the “Apply” button.

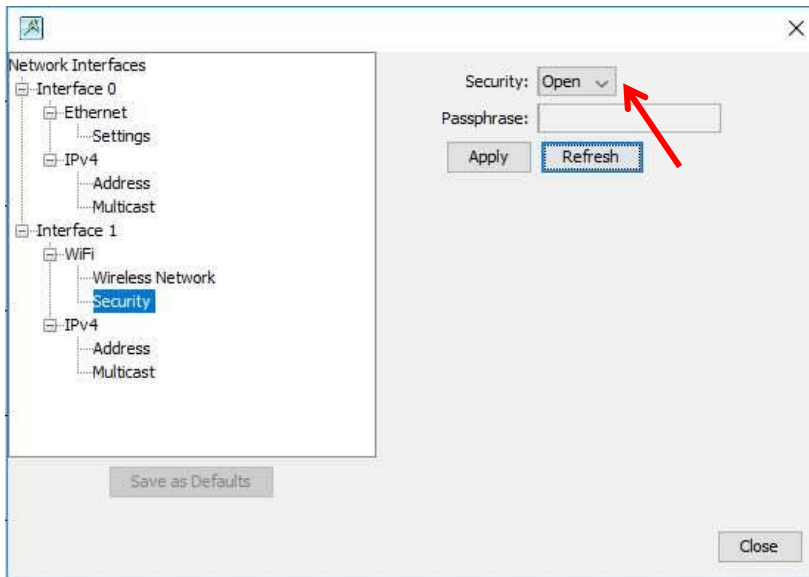

11. Then select Wireless Network under Interface 1. Change the mode to Access Point and then click the S/N button which loads the serial number of the connected Ocean FX. Click the “Apply” button.

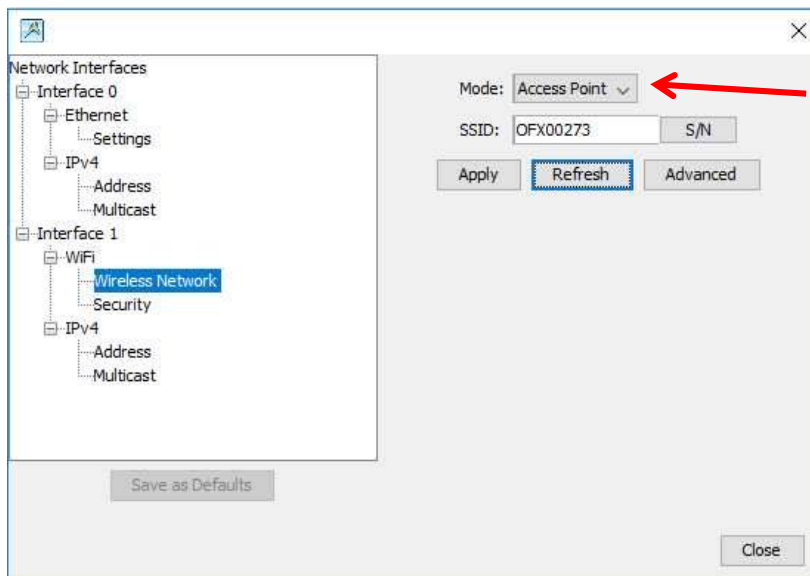

12. Select Address. Verify the “Enable DHCP” box is checked. If not, check the box.

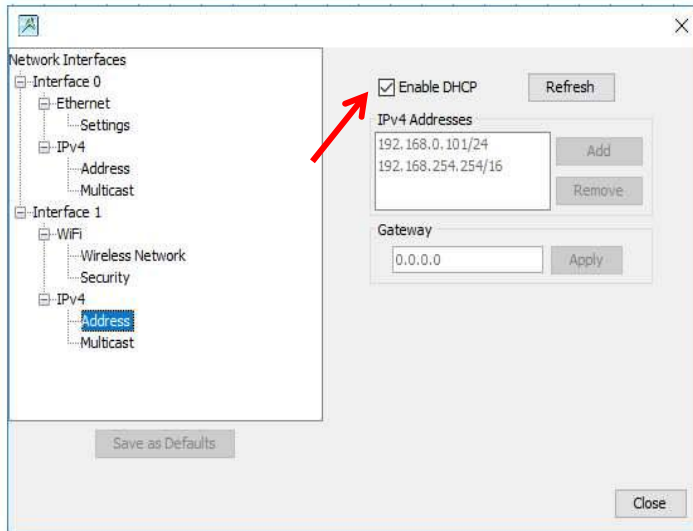

13. Verify that Enable Multicast has been checked. If necessary, click the “Enable Multicast (discovery)” button. Finally, select Interface 1 and then click the “Save as Defaults” button which will save the SSID and passphrase.

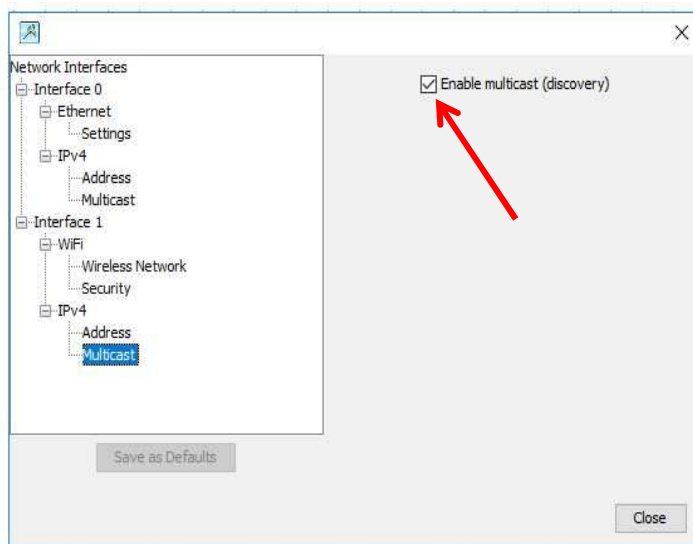

14. Select Interface 1 and then click the "Save as Defaults" button which will upload these settings to the Ocean FX. Click the Close button.

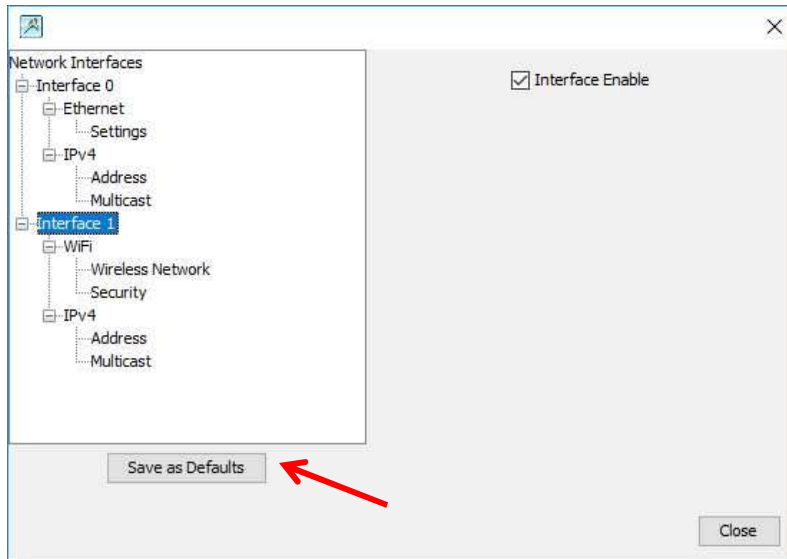

15. Disconnect USB cable from the Ocean FX.

16. Close OceanView and cycle power on the Ocean FX to enable the new settings. Wait 2 minutes.

- In your device's WiFi settings, choose and connect the Ocean FX WiFi option which will begin with "OFX" and then will have its serial number.



- Open OceanView which will connect wirelessly to the Ocean FX.
- If device does not appear correctly, consult the troubleshooting section.

Important Note

When using WiFi after initial configuration, wait 2 minutes after powering up the Ocean FX before opening OceanView.

- Continue your setup as described in the [Experiment Setup](#) section.

Power Sequences

Power ON Sequence

Power up the Ocean FX prior to opening controlling software such as OceanView. Before starting software, the following wait times are needed for proper connectivity operation:

USB:	No wait time
Ethernet:	Wait 1 minute
WiFi:	Wait 2 minutes

Power OFF Sequence

Close the controlling software before powering down the Ocean FX.

Experiment Setup

After the Ocean FX spectrometer is connected in OceanView as described above, you may continue the setup as shown below.

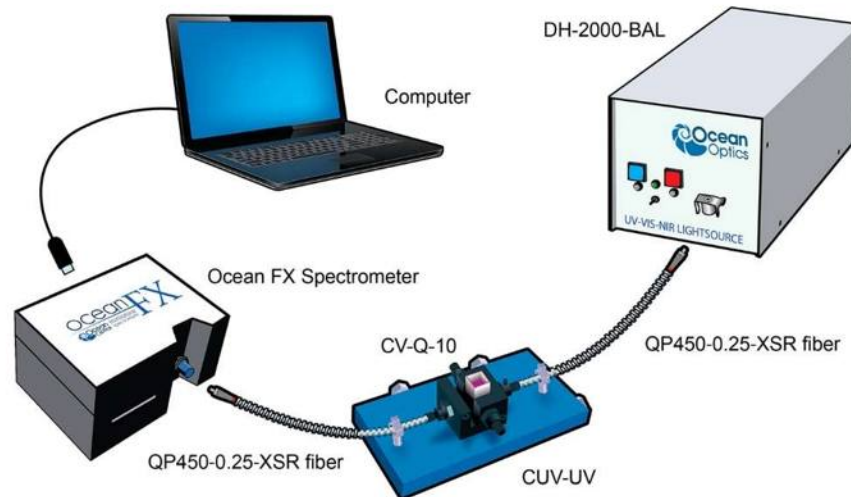

Ocean Optics Ocean FX Fiber Optic Spectrometer Typical Set-up

1. Connect any spectroscopy accessories. To find operating instructions for Ocean FX-compatible products (such as light sources, sampling chambers, and probes) go to the Technical Documents section of the Ocean Optics website under the Support menu.
2. Attach the fiber to the fiber optic connector on the spectrometer.

If you installed the spectrometer operating software prior to connecting the Ocean FX, the software automatically installs the Ocean FX drivers. If the drivers do not successfully install (or if you connected the Ocean FX to the computer before installing the software), consult the Troubleshooting section.

Important Note

The Ocean FX driver appears as USB2000+ to your computer since a common driver is used to ensure backwards and forwards compatibility. This does not affect functionality.

Ocean FX Indicator Lights

The Ocean FX features two indicator lights that operate as shown below:

Light	Steady	Flashing
red	Power is on, unit is booting or in idle state	Unit is acquiring data
green		Heartbeat

Table 9

Indicator lights can be turned off in OceanView or by using a firmware command.

Interchangeable Slits

The Ocean FX offers the capability of changing the slit size to match your measurement and application needs. You can order additional replacement slits either individually or as a kit (in various widths from 5 μm to 200 μm).

Changing the Interchangeable Slits

Caution

Only perform in a clean environment where contaminants cannot enter the bench during the procedure.

Important Note

If your application requires an absorbing filter, one is needed for each slit size.

Important Note

When changing the slit, there is no need to perform a wavelength calibration on the spectrometer. Just install and start measuring.

► **Procedure**

1. Find the SMA connector. If a fiber or protective cap is attached, remove it.



2. Use the Allen key to remove the 2 the screws attaching the slit to the spectrometer.
3. Pull the slit out of the spectrometer. This process is made easier by attaching the protective cap first.
4. Using the guide pins for proper alignment, put the new INTSMA slit connector into the spectrometer with the key of the connector on the left side.



5. Install the 2 screws again. Use the Allen key to tighten the screws carefully (do not over-tighten).
6. If necessary, remove the protective cap and connect the fiber again.

Accessories

Ocean Optics provides a range of standard cables and accessories that connect the Ocean FX to our large range of sampling and light source accessories utilizing the DD4 connector on the front of the Ocean FX spectrometer. Items specifically designed for the Ocean FX are described here; they are not provided with the Ocean FX spectrometer and must be purchased separately. Visit us at www.oceanoptics.com for a complete list of products available for all your spectroscopy needs.

Cables and Connectors

Cables are available to connect your Ocean FX Spectrometer to accessories such as light sources. Cable pinouts and descriptions are located in the Technical Specifications chapter.

Breakout Box (HR4-BREAKOUT)

The Breakout Box is a passive module that separates the signals from the Ocean FX's DD4 40-pin connector to an array of standard connectors and headers, enabling functionality with a wide range of accessories. In addition to the accessory connector, the breakout box features a circuit board based on a neutral breadboard pattern that allows custom circuitry to be prototyped on the board itself. See the Ocean Optics website for installation and operation instructions.

Light Sources, Cuvette Holders and Other Accessories

Ocean Optics supplies a large range of accessories for use with our spectrometers. This includes:

- Fibers
- Light Sources
- Integrated Sampling Systems
- Cuvettes, including microfluidic cuvettes
- Filter Holders & Filters including Low Pass, Band Pass and High Pass

Measurement Techniques – Typical Set-ups

The Ocean FX, in conjunction with Ocean Optics light sources and sampling accessories, can be used for many different measurement techniques. One of the key advantages of modular fiber optic spectroscopy is that you can change components of the system without having to buy a whole new system. Here, we show a range of typical UV-VIS set ups for basic spectroscopy techniques. Additional measurement techniques are presented on the Ocean Optics website.

Absorbance

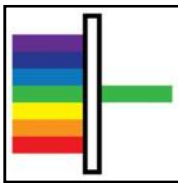

Absorbance is typically a relative measurement, comparing the spectrum from the sample to that of a reference. Absorbance is commonly used for concentration measurements and for identifying components in mixtures. The absorbance measurement scales the response logarithmically. Connect the [Product Name short] to our cuvette accessories via the SMA Adaptor accessory to take a liquid sample Absorbance measurement, or mount it directly against the sample with a light source on the opposite side for solid sampling.

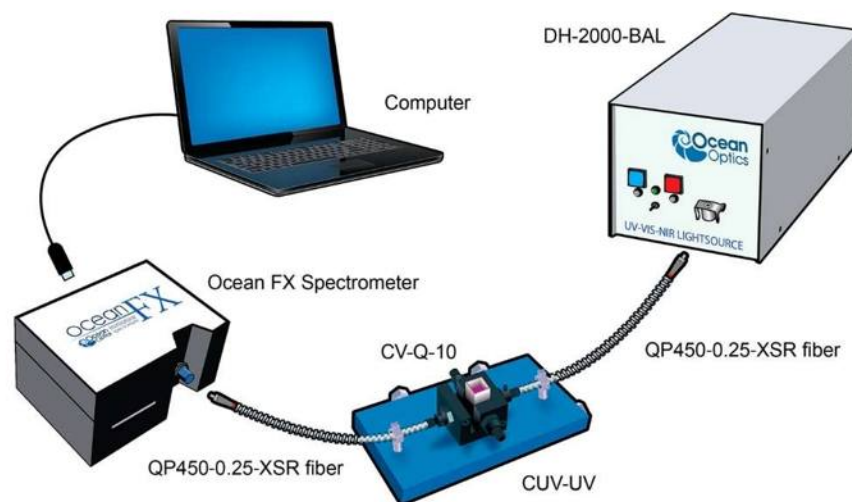

Typical Absorbance Set Up

Common UV-Vis Applications

- Quantification of DNA & proteins in life science samples
- Concentration of solutions & gaseous samples
- Identification of trace gases in a mixture

Reflectance & Transmission



Reflectance spectroscopy compares the relative level of light reflected off a sample compared with a reference (given as a percentage of the reference spectrum at each wavelength). A reflectance standard is used to set the reference level of 100%. Transmission is similar but compares the light transmitted through a sample relative to a reference rather than reflected off it. Typically, reflectance uses a fiber optic probe attached to a light source and a spectrometer, but measurements can also be done both in free-space or with the SMA Adaptor accessory. Transmission setups are usually the same as Absorbance setups.

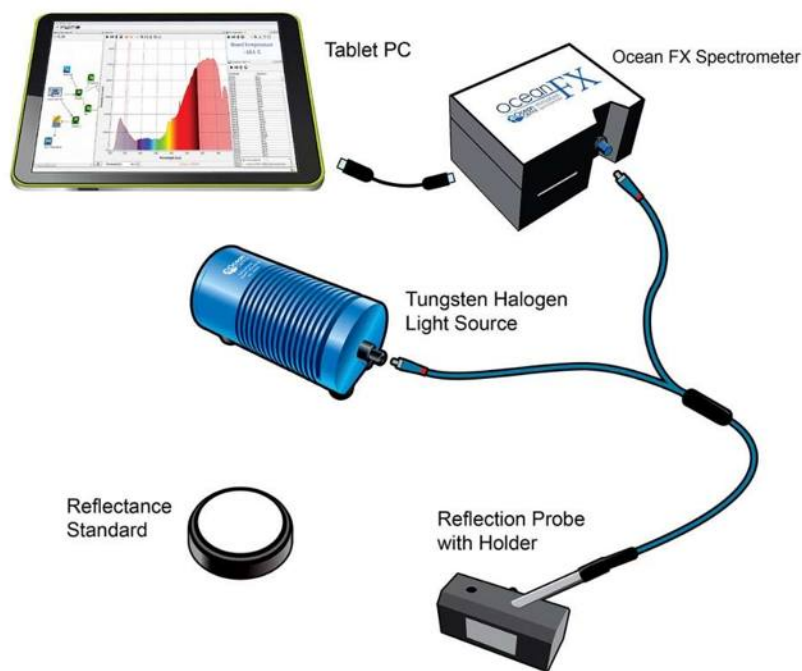

A Reflectance Set Up with Probe, Reflectance Standard and Probe Holder

Common UV-Vis Reflectance Applications

- Diffuse and Specular Color Measurements
- Process control for Surface quality of metals
- Thin film and semiconductor metrology

Common UV-Vis Transmission Applications

- Turbidity measurements of chemical solutions
- Measuring the transmission efficiency of optics and glass

Fluorescence

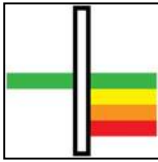

Fluorescence is a technique where a sample is excited with a light source and fluorescent light emitted from the sample at a higher wavelength is measured by the spectrometer. Typically the excitation source is applied at 90° to the sample to minimize light from the excitation source reaching the spectrometer. Filters are used to block lower wavelength light from reaching the detector. Spectrometers used for fluorescence typically have a large slit, sacrificing resolution for throughput sensitivity.

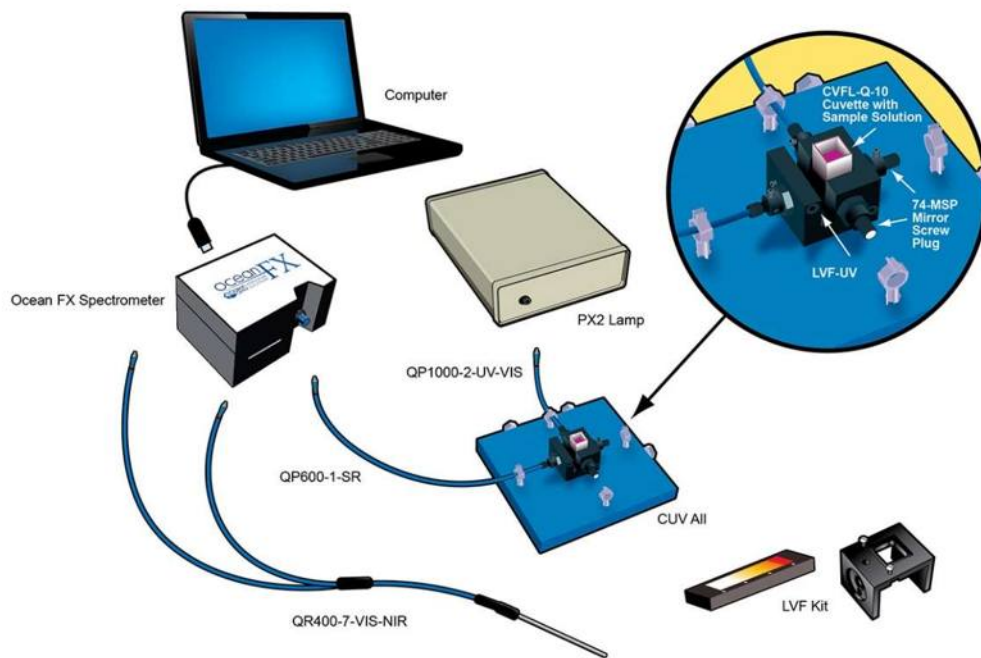

Typical Fluorescence Set Up with an LED Excitation Source at 90°

Common Fluorescence Applications

- Identifying proteins using fluorophores
- NADH fluorescence
- Remote sensing of chlorophyll
- Medical diagnosis of tumors and tissue types
- Detection of anti-counterfeiting tags

Irradiance

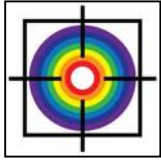

Irradiance is the technique of measuring the total energy of light at a given wavelength, either relative to the spectral output of a known source (relative irradiance) or in absolute units of power or energy (absolute irradiance). This is used widely in light metrology, color measurement and environmental science. Absolute irradiance measurements require an irradiance-calibrated spectral device. This can be done in the factory for some configurations or by using a calibration lamp in the lab or field. Every time a set-up is changed, the device used must be recalibrated.

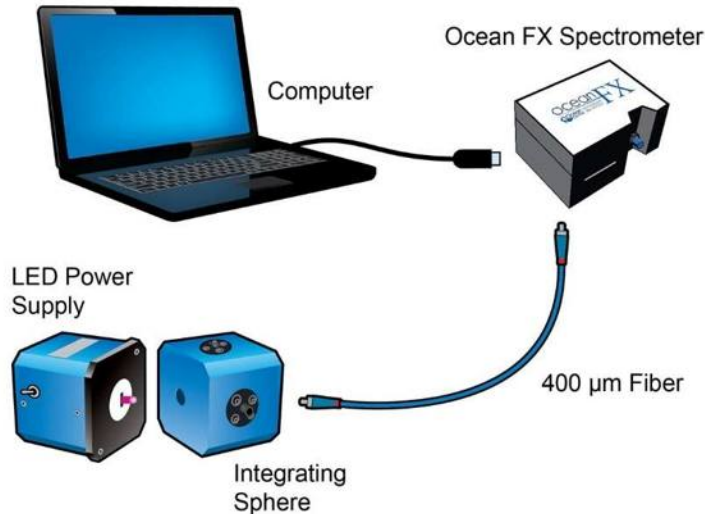

Typical Relative Irradiance Set-up for Measuring Light Power Output of an LED Using and Integrating Sphere

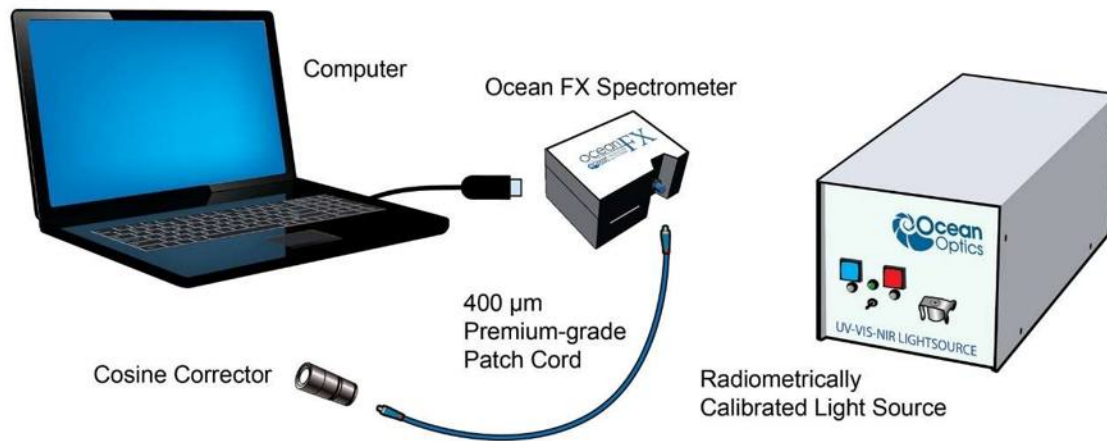

Typical Set-up for an Absolute Irradiance Measurement Using Field Calibration with a Calibrated Light Source

Common Irradiance Applications

- Measuring the radiant output of lamps and LEDs
- Measuring color using relative irradiance
- Measuring the color rendering index (CRI)
- Measuring UV exposure for health and safety

Ocean FX Operation with OceanView

Overview

The following information enables you to perform the basics of acquiring and saving data with your Ocean FX Spectrometer and OceanView software. More detailed information about OceanView is in the OceanView Manual.

Launch OceanView

Once you have installed your software and connected your spectrometer, start OceanView which will display the Welcome Screen.



The OceanView Welcome Screen (Version 1.6 and higher)

- **Quick View** - Displays the spectrum in Quick View mode showing raw, unprocessed data. This is uncorrected for instrument response vs. wavelength. Quick View shows you a live shot of what the Ocean FX[Product Name short] is “seeing”. From Quick View you can launch application wizards or construct your own method.
- **Load a Saved Project** - Loads a previously saved project. Click **Restore Last Session** to reload the schematic and views as they were when the software was last closed.
- **Spectroscopy Application Wizards** – Use this function to set up a measurement using simple step-by-step wizards. A large range of applications are available.

OceanView Main Screen

No matter what route you take on start up, you will soon end up on the OceanView main screen. This is where you can set and view acquisitions, save data, load data and save projects.

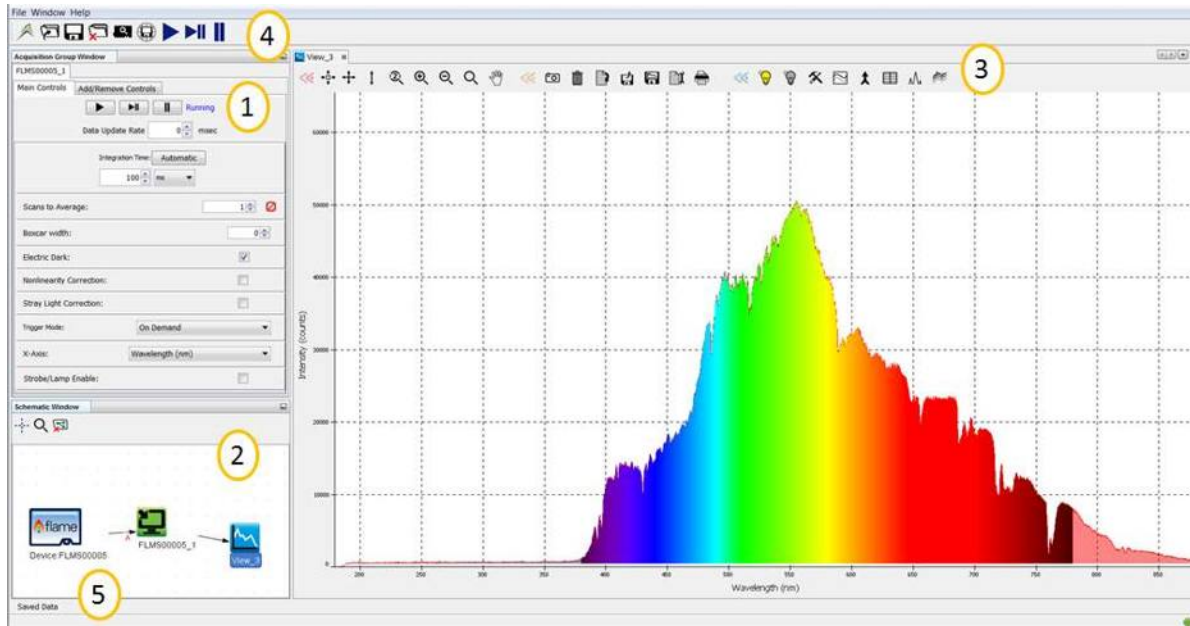

1. Acquisition Group Window	Use to set acquisition parameters such as integration time. Controls the spectrometer acquisition.
2. Schematic View	Schematic view graphically displays the flow of information from the spectrometer to the view. Use nodes to mathematically modify the data to create processed measurements (methods).
3. View Display	Display your data, view, save and display controls, as well as other features such as peak finder and quick dark & reference.
4. Global Controls	Control all spectrometers synchronously, save projects, and start a new application wizard.
5. Saved Data	Displays data saved in the active save file path. Preview data, store notes and load overlays directly to the active view. Click to open.

Connect the Ocean FX in OceanView

Refer to the **Initial Configuration** section for the initial steps for your new Ocean FX spectrometer. Once the initial configuration is done, follow the steps below for when you connect your device.

The Ocean FX should automatically appear when you start OceanView and should be acquiring with the default acquisition parameters. If you do not see a signal or the Ocean FX icon on the schematic you may need to rescan for spectrometers.

► Procedure

To rescan for attached devices,

1. Click on the Device Manager icon ().
2. Click Rescan. The spectrometer should automatically connect.

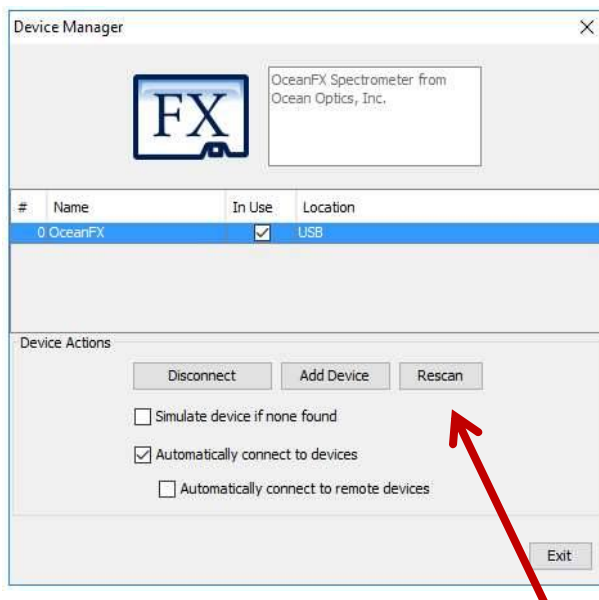

Set Acquisition Parameters

Set Acquisition parameters in the Acquisition Group Window to control the spectrometer. This window may be minimized when you first start OceanView. You can either expand or open a new window from the menu (Window | Acquisition Group). An active acquisition is required for the Acquisition window to appear. Functions available to control in the Acquisition window include the following:

- **Strobe/Lamp Enable (on/off)** – Use this function to turn an attached light source on or off.
- **Integration Time** – Sets the integration time, the time over which the detector captures incident light. At the end of the integration time the accumulated signal is read from the detector by the electronics.
- **Scans to Average** – Signal, especially at low levels, is often significantly impacted by noise. Averaging several spectra together reduces the impact of noise and provides a cleaner result. With the Ocean FX, averaging is done onboard which can significantly reduce spectral transfer times to the PC.
- **Boxcar Width** – Boxcar is a form of averaging across pixels. It applies a rolling average to multiple adjacent pixels to help smooth the spectral response and reduce the impact of noise.
- **Dark Spectrum** – A dark spectrum is the set of counts versus wavelength values for a spectrometer at a given integration time when no light is present. This spectrum is used to correct for baseline offset and fixed pattern noise. A dark spectrum must be stored to enable nonlinearity correction.
- **Nonlinearity Correction (on/off)** – Detectors do not have a completely linear response. As they approach saturation, typically their efficiency reduces.
- **Trigger Modes** – Sets triggering mode.
- **X-Axis** – Sets units for the X-axis.
- **Throughput** – Burst Mode acquires spectra into the onboard buffer of the OceanFX at the maximum acquisition rate of 4500 scans per second.

Controls that appear in this window depend on the spectrometer model. You can add and remove acquisition controls from this window in the Add/Remove Controls tab.

Burst Mode

Burst Mode is used to acquire spectral data at the fastest rate possible with the OceanFX (as fast as 4500 scans per second). When Burst Mode is enabled, the user specified number of spectra are acquired and written to the onboard buffer of the OceanFX. Once all the spectra have been acquired, the data can be written to a file by OceanView.

4: Operation

1. Before enabling Burst Mode, configure your file saving parameters by clicking the **Configure Graph Saving** button  in the Graph View.
2. In the **Algorithm Parameter Controls** dialog box that opens, specify the following:

- a. Select the **Time Series (column data)** File Format to write all the spectra collected during Burst Mode to one file.

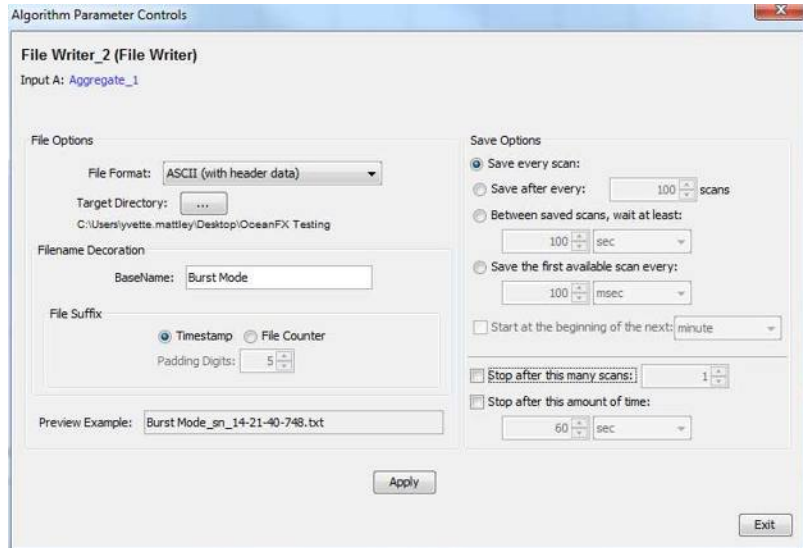

- b. Select the Target Directory where you want to save the file.

- c. Enter a Filename for your Burst Mode spectra.

- d. Under **Save** Options, select **Save Every Scan**. Confirm that the **Stop After This Many Scans** and **Stop After This Amount of Time** options are not selected.

- e. Click **Apply** and then **Exit** to save your file saving parameters.



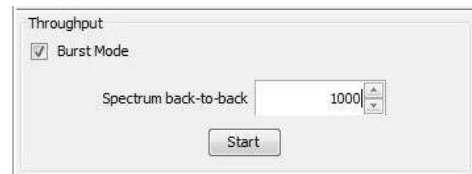

3. To enable Burst Mode acquisition, place a checkmark in the **Burst Mode** box in the **Throughput** panel of the **Acquisition Group Window** and enter the number of spectra you would like to acquire in burst mode.



Important Note



When Burst Mode is enabled, the OceanFX will stop acquiring spectral data until Burst Mode is initiated by clicking Start. This paused acquisition will cause the OceanFX to appear unresponsive. The OceanFX is still responsive in Burst Mode but will not acquire additional spectra until the Start button is clicked or the spectrometer is taken out of Burst Mode by unchecking the Burst Mode option.

4. Right click on the **Save Graph to Files** button  in the **Graph View** and select **Throughput Burst Mode** and then left click the **Save Graph to Files** button to initiate file saving. The button will turn red indicating that the software is ready to start saving Burst Mode data. File saving will not begin until the Burst Mode acquisition is started.



5. To start the Burst Mode acquisition, click the **Start** button in the **Throughput** panel of the **Acquisition Group Window**.
6. The message **File Saving in Progress...** will appear in the lower left corner of the software window while files are saving. This message will continue to be displayed until you click the **Save Graph to Files** button  in the **Graph View** to stop Burst Mode file saving.
7. With Burst Mode file saving enabled, a new set of burst mode files will be appended to your saved data file each time the **Start** button in the **Throughput** panel of the **Acquisition Group Window** is clicked.
8. To save each Burst Mode acquisition with a different filename:
 - a. Left click the **Save Graph to Files** button  in the **Graph View** to stop saving files in Burst Mode.
 - b. Click the **Configure Graph Saving** button  in the **Graph View** to change your filename.
 - c. Click **Apply** and then **Exit** to save your new filename before you exit the dialog box.
 - d. Left click the **Save Graph to Files** button  in the **Graph View** to initiate Burst Mode file saving.
 - e. Click the **Start** button in the **Throughput** panel to save Burst Mode files to your new filename.
9. To exit Burst Mode and return the spectrometer to free run mode:
 - a. Uncheck the **Burst Mode** box in the **Throughput** panel of the **Acquisition Group Window**
 - b. Left click the **Save Graph to Files** button  in the **Graph View** to stop **Throughput Burst Mode** file saving
10. To preview your data in the **Saved Data** view, click on the file you want to preview and click the **Play** button on the control menu.

Continuous and Single Acquisitions

There are two sets of controls for taking or pausing acquisitions. The set on the Acquisition group window allows you to control each device individually. The set on the top bar is a global control that will allow you to start and pause all devices currently attached.

	Acquire data continuously
	Take a single acquisition and then pause
	Pause all acquisitions.

Save Data

	Configure Saving, set saving parameters and file type, file directory and file naming convention. Once selected, the file directory will persist until changed.
	Start saving data. Turns red when save is active. If saving data continuously, click when red to stop saving. Will only activate saving for acquisitions attached to that particular view.
	Global Save. Activates all configured saves across all views. Use to save data from multiple devices at the same time.

By default OceanView will save data as a single “snapshot” acquisition. By configuring the save you can set the save behavior to fit your measurement needs, from single snap shots to a continuous stream of data over time.

Saved Data Panel

The saved data panel lets you see your data as it is saved and preview data. It also makes it simple to add overlays of saved data to your screen.

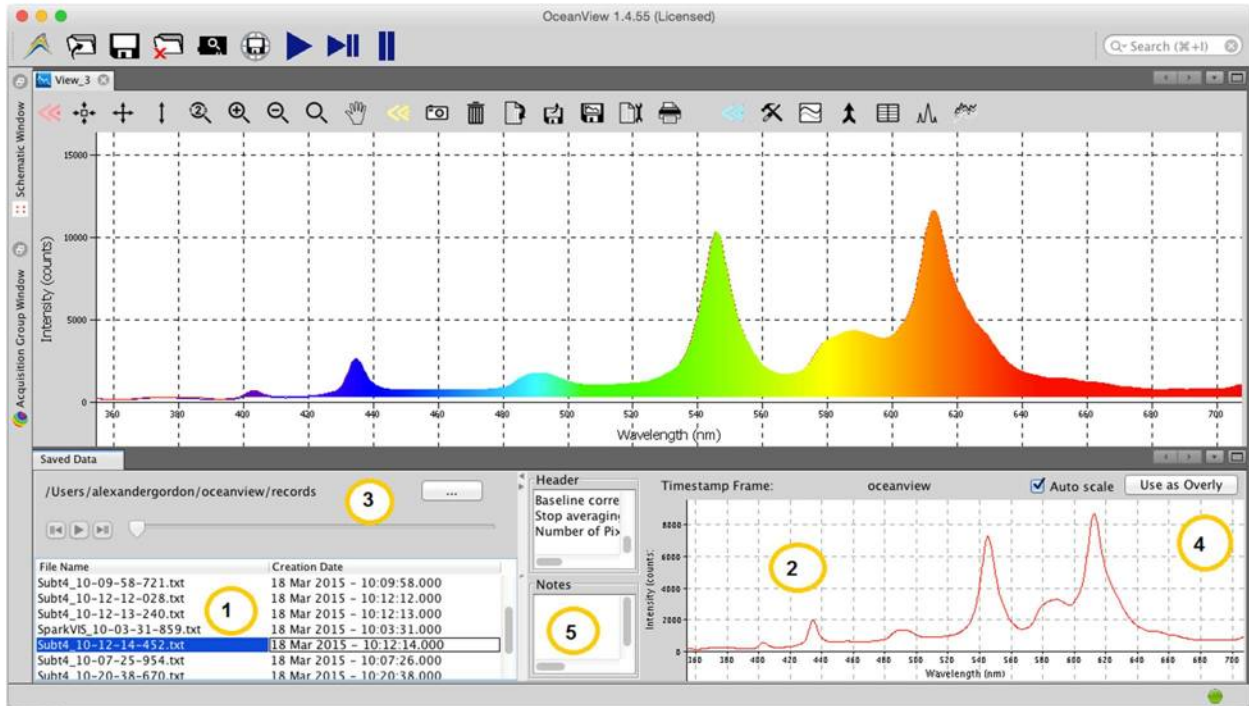

Saved Data Panel

1. Saved Files	List of saved files currently in the saved directory arranged by name or date.
2. Preview	Shows a preview of the saved spectra, time series or appended series saved data can be stepped through acquisition by acquisition using the controls above the saved files list.
3. File Path	Set the file directory.
4. Overlay	Set the previewed spectra as an overlay on the active view.
5. Notes	Enter notes about the saved spectra. Notes are saved with the same file name as a separate TSV file. These can be viewed or edited with any text viewer such as notepad.

Projects and Methods

OceanView makes it easy to save and load projects and methods. We define a project as a measurement set up made with a particular spectral device. If the software cannot find the device, it will load this as a method and prompt the user to select a substitute device from those selected.

	Click to save a project. Alternatively select <i>File Save Project</i> from the menu. Saves all view and schematic parameters to a single ASCII file.
	Load a project or method.

Spectroscopy Application Wizards

	<p>Click this button to set up a measurement using simple step by step wizards. A large range of applications is available.</p>
---	---





Application Wizard Window

Dark and Reference Measurements

Dark and reference measurements are commonly used in spectroscopy.

- **Dark Measurements** – subtract a background signal from the spectrum. This can be considered the removal of a constant error. Typically this is done when the light source is off to remove any background from the ambient environment, hence the name dark.
- **Reference Measurements** – make the signal relative to the reference. Consider this a normalization of the signal against a reference. Typically this is taken with a reference sample and the light source turned on. This lets you look at the relative spectral change compared to a reference sample.

Most often you will set up your measurement with the reference and dark through the application wizards. The wizards will prompt you to take your reference and darks. Alternatively you can use the quick dark and quick reference features. Once a dark and/or reference measurement has been set, you can update it with the controls on the top bar of the view.

	<p>Quick Reference – click to take a reference and set up a new view. After clicking it will prompt the user to take a dark.</p>
	<p>Quick Dark – click to take a dark measurement and sets up a new Quick View minus dark view.</p>

	Reference – click to update the stored reference measurement.
	Dark – click to update the stored dark measurement.

Schematic View

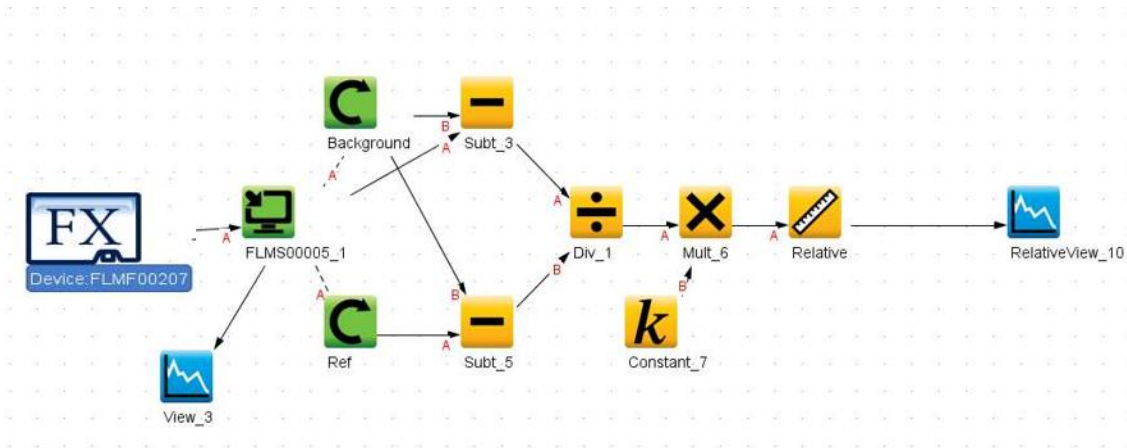

The schematic view is a graphical interface that allows you to move from device through to processed data. There are a few basic components to consider.

	Devices – Each spectrometer will appear as a separate device. Right click to open a menu that can generate an acquisition, control a TEC (if applicable) and add other device controls.
	Acquisitions – A spectrometer can output one acquisition per detector channel. Right click to open menu.
	Nodes – These are the building blocks of the schematic view. They are all various functions that take data in and provide an output. To make a node, right click on the schematic background. Each node can be configured by double clicking on the node. To join nodes press ctrl, click and drag (windows).
	Views – These are a type of window that displays data. To generate a new view right click on the schematic background.

More information about schematic view including detailed descriptions of the available nodes can be found in the *OceanView Installation and Operation Manual*.

Troubleshooting

Overview

Sometimes things do not go to plan. If not, do not hesitate to contact us and our Tech Support team will leap into action. Some typical questions are answered here. For more information, consult the FAQs on the Ocean Optics website.

Frequently Asked Questions

How do I know my spectrometer has power?

The red LED on the spectrometer should be on steadily if the unit is receiving power.

How do I know my spectrometer is transmitting data?

The red LED on the spectrometer flashes when transmitting data.

How do I check the configuration of my spectrometer?

Check the label on the bottom of your spectrometer. You can also check your configuration using your spectrometer operating software. In OceanView, open the Schematic window and double click the spectrometer icon.

I am installing OceanView but I need a product key. Where can I find this?

The product key was sent to the contact e-mail on the sales order when you purchased your OceanView license. Contact info@oceanoptics.com for more information. You'll need your sales order number, quotation number, the serial number of the spectrometer that was purchased with the software, and, if known, the e-mail address under which your product key was created to recover your key.

How do I determine whether my Windows computer is 32-bit or 64-bit?

Errors can occur if you download the wrong version of software (32-bit or 64-bit). Go to the Properties or Settings window and find system settings.

I connected the USB cable and started OceanView but I do not see my spectrometer attached.

Use the Rescan button in the Device Manager to rescan for attached devices.

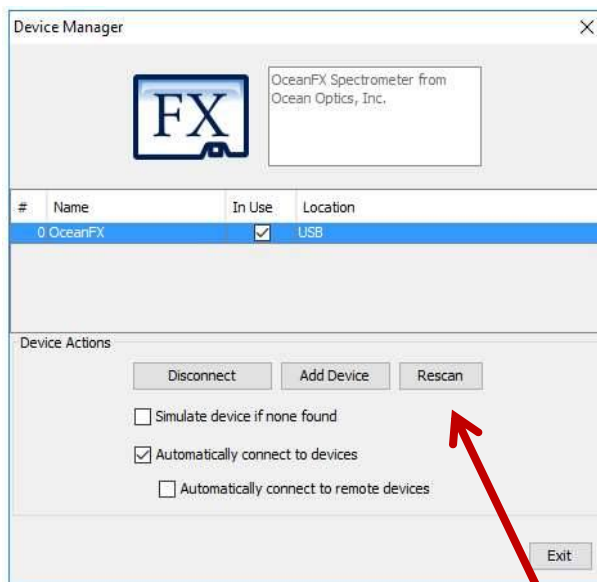

I am having trouble installing the drivers. What should I do?

Hardware device driver installation is usually seamless on Microsoft Windows operating systems and should happen in the background when you connect your spectrometer to a computer with the software installed. However, some Windows systems require a bit more care when connecting your spectrometer for the first time.

If your spectrometer is not recognized by OceanView on your computer, you need to manually install the spectrometer drivers. See your OceanView manual for this procedure. Also consult the *Correcting Device Driver Issues* document on the Ocean Optics website.

I connected the Ocean FX to the computer before installing my spectroscopy operating software to install the drivers. What do I do now?

The steps to take to resolve this issue differ, depending on your computer's operating system.

Microsoft Windows Operating Systems

Important Note

If these procedures do not correct your device driver problem, you must obtain the Correcting Device Driver Issues document from the Ocean Optics website.

Remove the Unknown Device from Windows Device Manager

► **Procedure**

1. Open Windows Device Manager. Consult the Windows operating instructions if needed.
 2. Locate the **Universal Serial Bus Devices** option and expand the **Universal Serial Bus Devices** selection by clicking on the "+" sign to the immediate left.
-

Important Note

Improperly installed USB devices can also appear under the Universal Serial Bus Controller option. Be sure to check this location if you cannot locate the unknown device.

3. Locate the unknown device (marked with a large question mark). Right-click on **the Unknown Device** listing and select the **Uninstall** or **Remove** option.
4. Click the **OK** button to continue. A warning box appears confirming the removal of the Unknown Device. Click the **OK** button to confirm the device removal.

Disconnect the Ocean FX from your computer and then re-connect the spectrometer to your computer. The system should now be able to locate and install the correct drivers for the USB device.

Apple Mac OSX Operating Systems

Since there are no device files for the Ocean FX Spectrometer in a Mac operating system, you should not encounter any problems if you installed the spectrometer before the spectrometer operating software.

Linux Operating Systems

For Linux operating systems, simply disconnect and then re-connect the USB cable in the spectrometer.

I have both SpectraSuite and OceanView installed. Will my spectrometer work with both?

Ocean FX only works with OceanView 1.6 and later.

I'm attempting to connect via Ethernet but I cannot see the spectrometer. What do I do?

Connect the spectrometer to the computer utilizing the USB cable. Using OceanView, verify the following:

In Network Connections:

- Interface 0 (network) is enabled.
- DHCP is enabled for Interface 0.

In Device Manager:

- See if device is displayed with an Ethernet connection/address. If not, rescan.
- If device is displayed but not connected, click the "connect" button.

I'm attempting to connect via WiFi, but I can't see the spectrometer. What do I do?

Initial setup must be done using the USB cable. If that has already been done, verify that the computer with OceanView resides on is on the same network and subnet as the spectrometer. Connect to the spectrometer utilizing the USB cable. Using OceanView, verify the following:

In Network Connections:

- Interface 1 (WiFi) is enabled.
- DHCP is enabled for Interface 1.

Security is set up with correct SSID and passphrase.

In Device Manager:

- See if device is displayed with a WiFi connection/address. If not, rescan.
- If device is displayed but not connected, click the "connect" button.

I configured my device via USB and am trying to connect to WiFi. Device manager shows the USB connection and then shows an error message "Error while communicating with the device. Reconnect device and rescan devices."

Verify the device is properly connected to its power source. In Device Manager, unselect "automatically connect to devices". Rescan. Once the device is displayed in the window, click "Connect" button. The device will appear. Reselect "Automatically Connect to Devices" option.

Product Upgrades, Repairs and Servicing

Occasionally, you may find that you need Ocean Optics to make a change or an upgrade to your system. To facilitate these changes, you must first contact Customer Support and obtain a Return Merchandise Authorization (RMA) number. Please contact Ocean Optics for specific instructions when returning a product.

Firmware Upgrades

Product enhancements can be accomplished within firmware and the new firmware revisions can be uploaded to the Ocean FX through OceanView. Below are upgrade instructions.

1. Go to the Ocean Optics website and download the two firmware files from the Software Downloads section. <https://oceanoptics.com/support/software-downloads/>
2. Connect your Ocean FX and open up OceanView (Version 1.6.3 or higher). Do not do this process wirelessly.
3. Go to the Schematic window and right click on the FX icon and click Update Firmware.

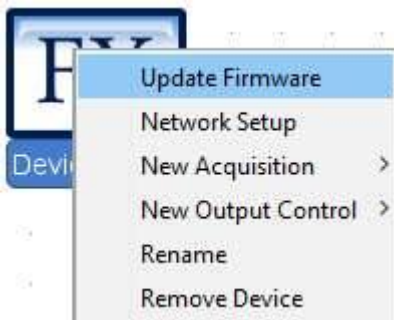

4. In the File Selection box, click the ... button to locate an OBP file. Choose the larger file.

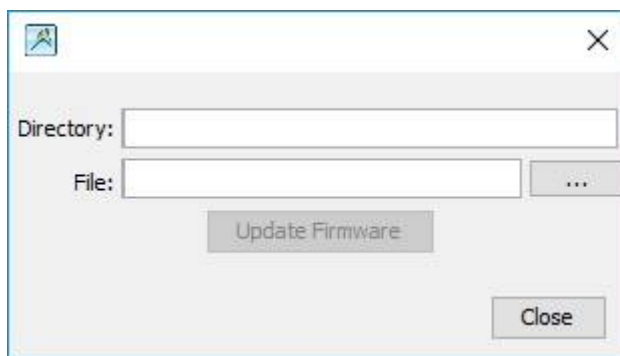

- Once a file has been selected, click the Upgrade Firmware button.

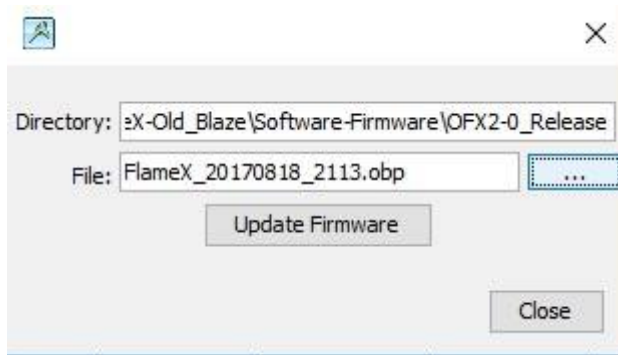

- Once complete, OceanView will ask to power-cycle the device. Power cycle the device and also close and restart OceanView.

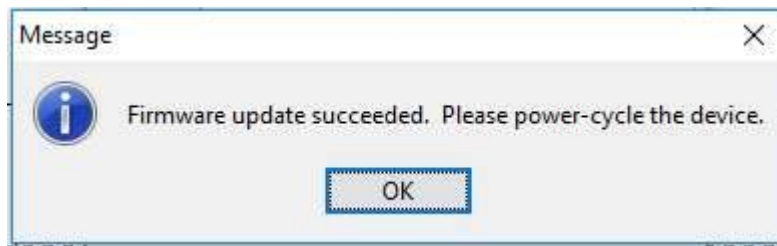

Repeat steps 3 through 6 for the second file and then close OceanView, power-cycle the Ocean FX and re-start OceanView.

Repairs

Sometimes accidents happen! If you need to return your Ocean Optics Product for repair, here is what to do:

► Procedure

- Contact us to speak to an Ocean Optics representative about the problem. If it is determined that the product must be returned, the representative will issue an RMA number.
- Package your product, ideally in the original packaging, and return it to Ocean Optics, along with the RMA number that you received.

Important Note

For RMA returns under warranty we will organize and pay for shipping both ways. For accidental damage, you only pay to have the product delivered to your closest Ocean Optics or OOI Distributor Office.

Upon careful examination, we'll advise you with an estimate. When your product is ready, it will be returned to you.

Servicing

To keep your instrument in tip top shape we recommend yearly wavelength recalibration. Contact your local representative to find out more about service availability and cost. We offer the following services:

- Wavelength Calibration
- Absolute Irradiance Calibrations

Technical Specifications

Mechanical Diagram

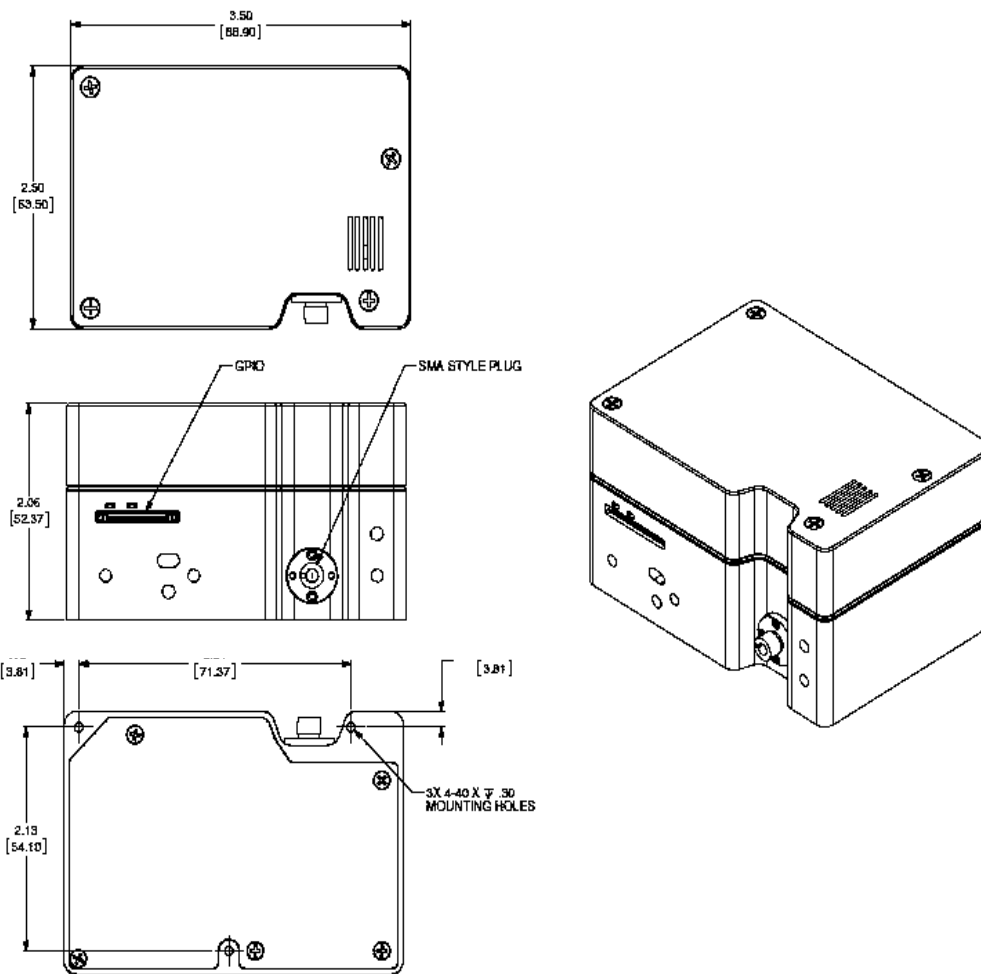

Ocean FX Outer Dimensions

Absolute Maximum Ratings

Input Voltage (Vin, VBatt, GPIO)	0 to +5.5V
Input Voltage (RS232)	+/- 25V
Input Voltage (I2C, SPI, Other I/O)	0 to +3.6V

Table 10

Performance Specifications

Storage Temperature	-30°C to +70°C
Storage Humidity	0 to 90% RH non-condensing
Operating Temperature	0°C to +50°C
Operating Humidity	0 to 90% RH non-condensing
Recommended Frequency of Calibration	The optical calibration should be performed annually
Ethernet	Gigabit transfer rate
USB 2.0, Type C connector	Up to 5Gbps data rate
WiFi	802.11 a/b/g/n

Table 11

Electrical Characteristics

PARAMETER	CONDITIONS	MIN	TYP	MAX	UNITS
Input Current <small>(Note 1)</small>	+5.0V, external power supply		0.9	2.5	A
Supply Voltage (V _{in})		4.75	5.0	5.25	V
GPIO Logic Input Low				0.9	V
GPIO Logic Input High		2.4			V
GPIO I _{SOURCE} / I _{SINK}			1.6		mA
GPIO Output Low	I _{SOURCE} = 1 mA			0.4	V
GPIO Output High	I _{SOURCE} = 1 mA	3.1			V
GPIO DAC Resolution			12		Bits
GPIO DAC Output Range		0		5	V
I2C / SPI Logic Level	I2C pullup resistor onboard		3.3		V
RS232 Output High		5.0	5.4		V
RS232 Output Low		-5.0	-5.4		V
Other I/O Voltage Range			3.3		V

Table 12

Note 1: Maximum input current includes 1.0A for powering accessories through the DD4 connector. If no accessories are powered through this connector, then maximum input current drops to 1.5A.

Optical and Spectroscopic Characteristics

PARAMETER	MIN	TYP	MAX	UNITS
Detector Response Range <small>(note 2)</small>	200		1100	nm
Integration Time	10		10E6	µs
Single Scan Dynamic Range		6423		
System Dynamic Range <small>(Note 3)</small>		7.3E7		
Single Scan Signal-to-Noise		290		
Resolution (FWHM) <small>(Note 4)</small>		2.39		nm
Stray Light <small>(Note 5)</small>		1.9		a.u.
Max Scan Rate			4500	Scans
Buffer Depth			50000	Spectra
Thermal Stability		0.11		Pixels/°C
Trigger Jitter			21	ns

Table 13

Note 2: Spectral range for each spectrometer will be determined by specific features of the optical components.

Note 3: Dynamic range of the system is the range of the detectable light level and can be thought of as the maximum detectable light level at the minimum integration time divided by the minimum detectable light level at the maximum integration time.

Note 4: Optical resolution of a spectrometer, measured as full width at half maximum (FWHM), depends on the groove density of the grating and the diameter of the entrance optics (optical fiber or slit). A G01 600/300 grating and 5 µm slit is used for this measurement.

Note 5: Stray light is reported here as the average of the stray light measured across 5 regions of the systems wavelength range.

Mechanical Specifications

PARAMETER	SPECIFICATION
Spectrometer Topology	Asymmetric Crossed Czerny-Turner
Input Fiber Connector	SMA 905 or FC/PC
Entrance Slit	5, 10, 25, 50, 100, or 200 µm slits. (Slits are optional. In the absence of a slit, the fiber acts as the entrance slit.)
Gratings	Specifications vary by grating choice
Physical Dimensions	88.9 mm x 63.5 mm x 52.4 mm
Weight	0.4 kg (14.1 oz)
Mounting	No restrictions on mounting. Can be mounted at any angle or position.

Table 14

Accessory Connectors

DD4 Accessory Connector

The [Product Name short] Ocean FX features a 40-pin Accessory Connector, located on the front of the unit as shown:



Location of [Product Name short] Accessory Connector

The Ocean FX features a 40-pin Accessory Connector (Part Number: DD4RA40JA1) that has two mating connectors available: DD4PA40MA1 (right angle) and DD4BA40WA1 (vertical). Pin 1 is on the right when viewing the 40-pin Accessory Connector from the front of the spectrometer. [Product Name short] This connector is used to connect sampling and light sources to the Ocean FX.

DD4 Accessory Connector Pinout

PIN#	SIGNAL NAME	VOLTAGE	DESCRIPTION
1	GND	0	System Ground
2	IO_TRIG_EXT	+3.3	Programmable Hardware Trigger
3	IO_STROBE_CONT_EXT	+3.3	Programmable Continuous Strobe
4	IO_STROBE_SINGL_EXT	+3.3	Programmable Single Strobe
5	LAMP_EN	+3.3	Programmable Discrete Output

6: Technical Specifications

PIN#	SIGNAL NAME	VOLTAGE	DESCRIPTION
6	GPIO_0	+3.3/+5.0	General Purpose Software Programmable Digital Inputs/Output, Analog Output. Digital Outputs are 3.3V. Analog Outputs Can Be Programmed To 2.5V or 5.0V Max.
7	GPIO_1		
8	GPIO_2		
9	GPIO_3		
10	GND		
11	GPIO_4		
12	GPIO_5		
13	GPIO_6		
14	GPIO_7 (Analog Out)		
15	GND	0	System Ground
16	SPI_SCLK	+3.3	Master Clock.
17	SPI_MOSI	+3.3	The SPI Master Out Slave In (MOSI) signal is for communications to other SPI peripherals. See SPI below.
18	SPI_CS	+3.3	SPI Chip Select signal. See SPI Below.
19	SPI_MISO	+3.3	The SPI Master In Slave Out (MISO) signal is for communications to other SPI peripherals. See SPI below.
20	GND	0	System Ground
21	I2C4_SCL	+3.3	I2C Master Clock. See I2C below.
22	I2C4_SDA	+3.3	I2C Master Data. See I2C below.
23	GND	0	System Ground
24	RS232_TX	-6 to +6	RS232 Transmit Signal
25	RS232_RX	-25 to +25	RS232 Receive Signal
26	RS232_CTS	-6 to +6	RS232 Clear To Send
27	RS232_RTS	-25 to +25	RS232 Request To Send
28	IO_RESET#	+5.0	Pull Low to reset device
29	IO_PWR_DIR#	+5.0	IO Power Direction. Pull down to request power.
30	IO_PWR_LVL	+3.3	IO Power Level - Low Indicates 100mA Available - High Indicates 1A Available
31	Reserved		Reserved
32	+5V_GPIO	+5.0	5V Input / Output
33	+5V_GPIO		
34	+5V_GPIO		
35	+5V_GPIO		
36	+5V_GPIO		
37	+5V_GPIO		
38	+5V_GPIO		
39	GND	0	System Ground
40	+5V_GPIO	+5.0	5V Input / Output

Table 15

SPI

The Ocean FX has the ability to function as a SPI master through the SPI port which comprises the SPI Master Clock, SPI Master MOSI, SPI Master CS and SPI Master MISO pins. To send messages over the SPI port, use the General SPI Input/Output message. The Ocean FX does not send or receive any SPI data without direction from the host device. Because SPI is a full-duplex transaction, the General SPI Input/Output message both reads and writes at the same time. For instance, a four byte write will return four bytes of dummy read data, and a four byte read requires four bytes of dummy write data:

- MOSI data is established just prior to the rising edge of the SPI clock
- MISO data is sampled just after a falling edge of the SPI clock.

If using SPI as a master, consult the *Ocean FX Firmware and Advanced Communications* document for more details. Consult with an Ocean Optics Sales Manager to obtain this document.

I2C

The Ocean FX has the ability to function as an I2C master through the I2C port, which includes the I2C-SDA (data), and I2C-SCL (clock) pins. To send messages over the I2C port, use the General I2C Write and General I2C Read messages. Note that the Ocean FX does not send or receive any I2C data without direction from the host system. The I2C lines are pulled up internally.

If using I2C communication, consult the *Ocean FX Firmware and Advanced Communications* document for more details. Consult with an Ocean Optics Sales Manager to obtain this document.

DB15 Connector Cable (FLAME-CBL-DD4P-DB15P)

This cable connects the Ocean FX to existing Ocean Optics accessories that use a DB-15HD connector. These include most light sources.

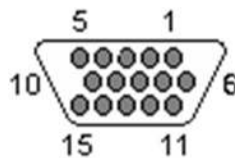

DD4 to DB15 Pin Connections

15 PIN	DD4	Name
1	4	Single Strobe
2	3	Continuous Strobe

6: Technical Specifications

3	40	Vusb
4	2	External Trigger In
5	2	External Trigger In
6	7	GPIO 1
7	NC	Reserved (NC)
8	2	External Trigger In
9	8	GPIO 2
10	1	Ground
11	22	I2C SDA
12	21	I2C SCL
13	5	Lamp Enable
14	NC	Reserved (NC)
15	11	GPIO 4

Table 16

Chapter 7

Calibration

Overview

This chapter provides information for performing your own wavelength calibration and irradiance calibration.

An EEPROM flash memory chip in each Ocean FX contains wavelength calibration coefficients, linearity coefficients, and a serial number unique to each individual spectrometer. The spectrometer operating software application reads these values directly from the spectrometer, enabling the ability to “hot-swap” spectrometers between host devices without entering the spectrometer coefficients manually on each host device.

OceanView can be used to write calibration coefficients to the spectrometer and reload firmware if the spectrometer becomes corrupted.

Wavelength Calibration

This section describes how to calibrate the wavelength of your spectrometer. Though each spectrometer is calibrated before it leaves Ocean Optics, the wavelength for all spectrometers will drift slightly as a function of time and environmental conditions. See the Technical Specifications for recommended calibration frequency.

About Wavelength Calibration

You are going to be solving the following equation, which shows that the relationship between pixel number and wavelength is a third-order polynomial:

$$\lambda_p = I + C_1 p + C_2 p^2 + C_3 p^3$$

Where:

λ = the wavelength of pixel p

I = the wavelength of pixel 0

C_1 = the first coefficient (nm/pixel)

C_2 = the second coefficient (nm/pixel²)

C_3 = the third coefficient (nm/pixel³)

You will be calculating the value for I and the three C s.

Calibrating the Spectrometer Wavelength

Preparing for Calibration

To recalibrate the wavelength of your spectrometer, you need the following components:

- A light source capable of producing spectral lines

Important Note

Ocean Optics' HG-1 Mercury-Argon lamp is ideal for recalibration. If you do not have an HG-1, you need a light source that produces several (at least 4-6) spectral lines in the wavelength region of your spectrometer.

- An Ocean FX spectrometer
- An optical fiber (for spectrometers without a built-in slit, a 50- μ m fiber works best)
- A spreadsheet program (Excel for example) or a calculator that performs third-order linear regressions

Calibrating the Wavelength of the Spectrometer

► Procedure

1. Place the spectrometer operating software into Quick View (Scope) mode and take a spectrum of your light source. Adjust the integration time (or the A/D conversion frequency) until there are several peaks on the screen that are not off-scale.
2. Move the cursor to one of the peaks and position the cursor so that it is at the point of maximum intensity.
3. Record the pixel number that is displayed in the status bar or legend (located beneath the graph). Repeat this step for all peaks in your spectrum.
4. Use the spreadsheet program or calculator to create a table like the one shown in the following figure. In the first column, place the exact or true wavelength of the spectral lines that you used.

In the second column of this worksheet, place the observed pixel number. In the third column, calculate the pixel number squared, and in the fourth column, calculate the pixel number cubed.

Independent Variable	Dependent Variables			Values Computed from the Regression Output	
True Wavelength (nm)	Pixel #	Pixel # ²	Pixel # ³	Predicted Wavelength	Difference
253.65	175	30625	5359375	253.56	0.09
296.73	296	87616	25934336	296.72	0.01
302.15	312	97344	30371328	302.40	-0.25
313.16	342	116964	40001688	313.02	0.13
334.15	402	161604	64964808	334.19	-0.05
365.02	490	240100	117649000	365.05	-0.04
404.66	604	364816	220348864	404.67	-0.01
407.78	613	375769	230346397	407.78	0.00
435.84	694	481636	334255384	435.65	0.19
546.07	1022	1044484	1067462648	546.13	-0.06
576.96	1116	1245456	1389928896	577.05	-0.09
579.07	1122	1258884	1412467848	579.01	0.06
696.54	1491	2223081	3314613771	696.70	-0.15
706.72	1523	2319529	3532642667	706.62	0.10
727.29	1590	2528100	4019679000	727.24	0.06
738.40	1627	2647129	4306878883	738.53	-0.13
751.47	1669	2785561	4649101309	751.27	0.19

- Use the spreadsheet or calculator to calculate the wavelength calibration coefficients. In the spreadsheet program, find the functions to perform linear regressions.
- Select the true wavelength as the dependent variable (Y). Select the pixel number, pixel number squared, and the pixel number cubed as the independent variables (X). After executing the regression, you will obtain an output like the one shown below. Numbers of importance are noted.

Regression Statistics

Multiple R 0.999999831
 R Square 0.999999663 ← R Squared
 Adjusted R Square 0.999999607
 Standard Error 0.125540214
 Observations 22

	<u>Coefficients</u>	<u>Standard Error</u>	
Intercept	190.473993	0.369047536	← First coefficient
X Variable 1	0.36263983	0.001684745	
X Variable 2	-1.174416E-05	8.35279E-07	← Second coefficient
X Variable 3	-2.523787E-09	2.656608E-10	← Third coefficient

7. Record the Intercept, as well as the First, Second, and Third Coefficients. Additionally, look at the value for R squared. It should be very close to 1. If not, you have most likely assigned one of your wavelengths incorrectly.

Keep these values at hand.

Saving the New Calibration Coefficients: OceanView

Ocean Optics programs wavelength calibration coefficients unique to each Ocean FX onto an EEPROM memory chip in the Ocean FX.

You can overwrite old calibration coefficients on the EEPROM if you are communicating with the Ocean FX via OceanView. Extreme caution must be used when performing this step. Contact Ocean Optics for assistance and the necessary password to perform this function in OceanView.

► Procedure

1. Ensure the Ocean FX device is properly connected.
2. Select the "Acquisition Group Window" -> "Add/Remove Controls" -> "Wavelength Coefficients".
3. Enter password provided by Ocean Optics.
4. Follow the instructions provided by Ocean Optics.

Irradiance Calibrations

Irradiance calibrations and relative irradiance calibrations are about quantifying the spectra, by translating the signal to a calibration. This can be either absolute (an atomic emission light source of known output power) or relative (corrected for instrument response function but not absolute units). It can be considered a measurement technique and is used widely in remote sensing, light metrology and anywhere where you wish to characterize the incident light source. Irradiance calibrations are not required for many techniques because these measure the relative signal changes with respect to the sample and not the light source.

OceanView has wizards that will step you through absolute irradiance and relative calibrations and more information on these is in the OceanView manual.