

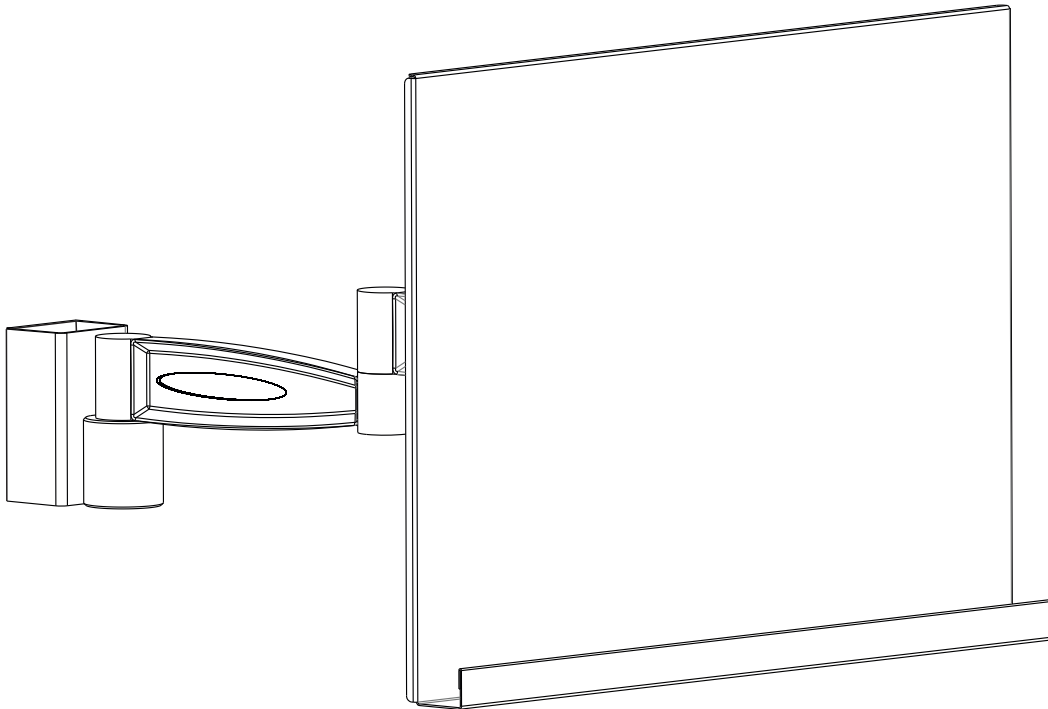

VIKING

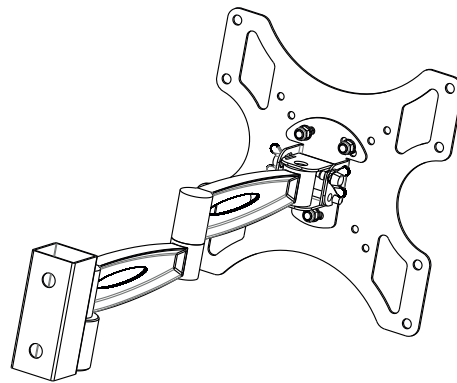

1x 1.6.3.2x10AЛ АЛ	2x 1.1.912.10x16	2x 2.10.1.20
--	----------------------------	------------------------



1x
ППЧ.1.01.00

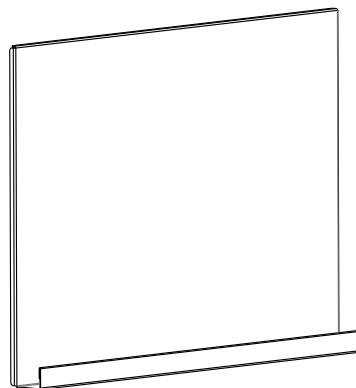

1

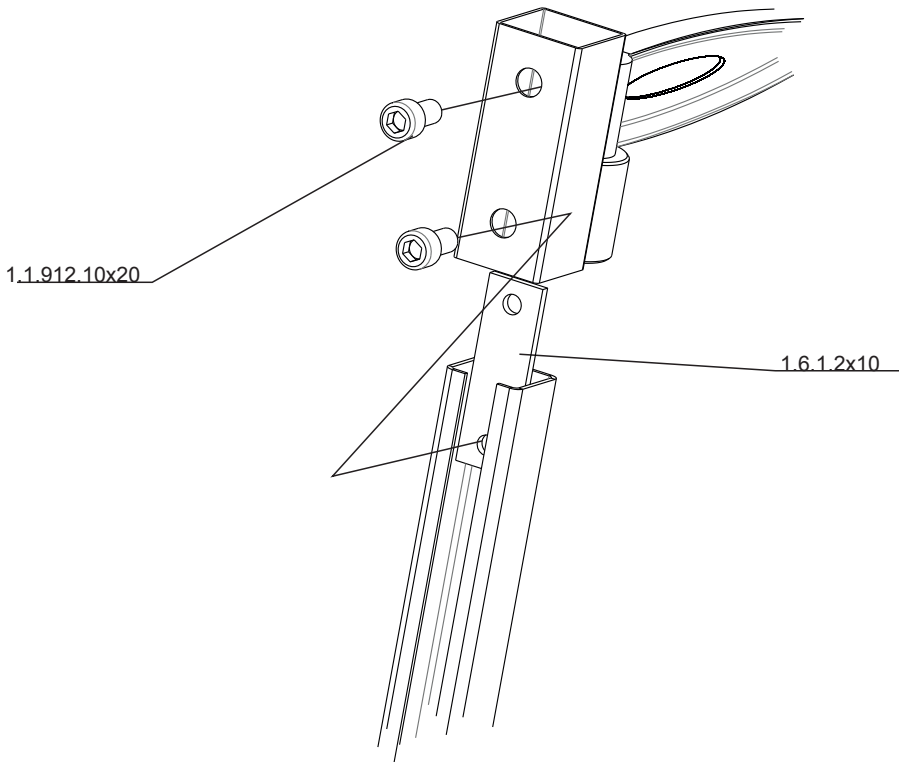

2

